

Regulation No 98 of the Economic Commission for Europe of the United Nations (UN/ECE) uniform provisions concerning the approval of motor vehicle headlamps equipped with gas-discharge light sources⁽¹⁾

A. ADMINISTRATIVE PROVISIONS

SCOPE⁽²⁾

This Regulation applies to motor vehicle headlamps equipped with gas discharge light source(s) which may incorporate lenses of glass or plastic material.

1. DEFINITIONS

For the purpose of this Regulation,

- 1.1. 'Lens' means the outermost component of the headlamp (unit) which transmits light through the illuminating surface;
- 1.2. 'Coating' means any product or products applied in one or more layers to the outer face of a lens;
- 1.3. 'Ballast' means the electrical supply of the gas-discharge light source. This ballast may be partly or completely inside or outside the headlamp;
- 1.4. 'Matched pair' means the set of lamps of the same function on the left- and right-hand side of the vehicle;
- 1.5. Additional definitions are given in Regulation No 48;
- 1.6. Headlamps of different 'types' are headlamps which differ in such essential respects as:
 - 1.6.1. the trade name or mark;
 - 1.6.2. the characteristics of the optical system;
 - 1.6.3. the inclusion or elimination of components capable of altering the optical effects by reflection, refraction, absorption and/or deformation during operation. However, the fitting or elimination of filters intended solely to change the colour of the beam and not its light distribution does not entail a change of type;
 - 1.6.4. suitability for right-hand or left-hand or for both traffic systems;

⁽¹⁾ Regulation of the United Nations Economic Commission for Europe published pursuant to the provisions of Article 4 (5) of Council Decision 97/836/EC (OJ L 346, 17.12.1997, p. 78).

⁽²⁾ Nothing in this Regulation shall prevent a Contracting Party to the Agreement applying this Regulation from prohibiting the combination of a headlamp approved 'PL' (Plastic Lens) under this Regulation with a mechanical headlamp-cleaning (i.e. with wipers) on vehicles which it registers.

- 1.6.5. the kind of beam produced (passing beam or driving beam or both);
- 1.6.6. the materials constituting the lenses and coating, if any;
- 1.7. 'Light-transmitting components' means any part of the headlamp which transmits light for illumination, such as outer and inner lenses, lens or reflector coatings.
2. APPLICATION FOR APPROVAL OF A HEADLAMP⁽¹⁾
- 2.1. The application for approval shall be submitted by the owner of the trade name or mark of the headlamp or by his duly accredited representative. It shall specify:
- 2.1.1. whether the headlamp is intended to provide a passing beam, a driving beam or both;
- 2.1.2. whether, if the headlamp is intended to provide a passing beam, it is designed for both left-hand and right-hand traffic or for either left-hand or right-hand traffic only;
- 2.1.3. if the headlamp is equipped with an adjustable reflector, the mounting position(s) of the headlamp in relation to the ground and the longitudinal median plane of the vehicle;
- 2.1.4. the maximum vertical angles above and below the nominal position(s) which the aiming device can achieve;
- 2.1.5. which light sources are energised when the various beam combinations are used;
- 2.1.6. the category of gas-discharge light source as listed in Regulation No 99.
- 2.2. Every application shall be accompanied by:
- 2.2.1. drawings in triplicate in sufficient detail to permit identification of the type (see paragraphs 3.2 and 4.2 below). The drawings must show the position intended for the approval number and the additional symbols in relation to the circle of the approval mark, and must show the headlamp in vertical (axial) section and in front elevation, with main details of the optical design including the flutings, if applicable.
- 2.2.2. A brief technical specification including the make and types of the ballast(s), where it applies.
- 2.2.3. Samples, as follows:
- 2.2.3.1. for approval of a headlamp, two samples with standard gas-discharge light source and one ballast of each type to be used, where applicable;

⁽¹⁾ For gas-discharge light sources see Regulation No 99.

- 2.2.4. For the test of plastic material of which the lenses are made:
- 2.2.4.1. fourteen lenses;
- 2.2.4.1.1. ten of these lenses may be replaced by ten samples of material, at least 60 x 80 mm in size, having a flat or convex outer surface and a substantially flat area (radius of curvature not less than 300 mm) in the middle measuring at least 15 × 15 mm.
- 2.2.4.1.2. every such lens or sample of material shall be produced by the method to be used in mass production;
- 2.2.4.2. a reflector to which the lenses can be fitted in accordance with the manufacturer's instructions.
- 2.2.5. For testing the UV-resistance of light transmitting components made of plastic material against UV radiation of gas-discharge light sources inside the headlamp:
- 2.2.5.1. One sample each of the relevant material as being used in the headlamp or one headlamp sample containing these. Each material sample shall have the same appearance and surface treatment —if any—as intended for use in the headlamp to be approved.
- 2.2.5.2. The UV-resistance testing of internal materials to light source radiation is not necessary if low-UV-type gas-discharge light sources are being applied as specified in Regulation XXX (TRANS/SC.1/WP.29/GRE/R.195) or if provisions are taken, to shield the relevant headlamp components from UV radiation, e.g. by glass filters.
- 2.3. The materials making up the lenses and coatings, if any, shall be accompanied by the test report of the characteristics of these materials and coatings if they have already been tested.
- 2.4. The competent authority shall verify the existence of satisfactory arrangements for ensuring effective control of the conformity of production before type approval is granted.
3. MARKINGS⁽¹⁾
- 3.1. Headlamps submitted for approval shall bear legibly and indelibly on the lens the trade name or mark of the applicant.
- 3.2. They shall comprise, on the lens and on the main body⁽²⁾, spaces of sufficient size for the approval mark and the additional symbols referred to in paragraph 4; these spaces shall be indicated on the drawings referred to in paragraph 2.2.1 above.

⁽¹⁾ In the case of headlamps designed to meet the requirements of traffic moving on one side of the road only (either right or left) it is further recommended that the area which can be occulted to prevent discomfort to users in a country where traffic moves on the side of the road opposite to that of the country for which the headlamp was designed should be outlined indelibly on the front lens and explained in the maintenance book of the vehicles. This marking is not necessary, however, where the area is clearly apparent from the design.

⁽²⁾ If the lens cannot be separated from the main body of the headlamp, the provision of a marking area on the lens will suffice.

- 3.3. Headlamps designed to satisfy the requirements of both right-hand and left-hand traffic shall bear markings indicating the two settings of the optical unit on the vehicle or of the gas-discharge light source on the reflector; these markings shall consist of the letters 'R/D' for the position for right-hand traffic and the letters 'L/G' for the position for left-hand traffic.
- 3.4. All beams may bear on their light-emitting surface a centre of reference as shown in annex 6.
4. APPROVAL
- 4.1. *General*
- 4.1.1. If all the samples of a type of headlamp submitted pursuant to paragraph 2 above satisfy the provisions of this Regulation, approval shall be granted.
- 4.1.2. Headlamps conforming to this Regulation may be grouped, combined or reciprocally incorporated with any other lighting or light-signalling function(s) provided that their respective lighting functions are not impaired.
- 4.1.3. Where grouped, combined or reciprocally incorporated lamps satisfy the requirements of more than one Regulation, a single international approval mark may be affixed provided that each of the grouped, combined or reciprocally incorporated lamps satisfies the provisions applicable to it.
- 4.1.4. An approval number shall be assigned to each type approved. Its first two digits (at present 00) shall indicate the series of amendments incorporating the most recent major technical amendments made to the Regulation at the time of issue of the approval. The same Contracting Party may not assign the same number to another type of headlamp covered by this Regulation. However, the matched pair is considered to be one type.
- 4.1.5. Notice of approval or of extension or refusal or withdrawal of approval or production definitely discontinued of a type of headlamp pursuant to this Regulation shall be communicated to the Parties to the 1958 Agreement applying this Regulation, by means of a communication form conforming to the model in annex 1 to this Regulation.
- 4.1.6. In addition to the mark prescribed in paragraph 3.1, an approval mark as described in paragraphs 4.2 and 4.3 below shall be affixed in the spaces referred to in paragraph 3.2 above to every headlamp conforming to a type approved under this Regulation.
- 4.2. Composition of the approval mark
- The approval mark shall consist of:
- 4.2.1. An international approval marking, comprising:

- 4.2.1.1. a circle surrounding the letter 'E' followed by the distinguishing number of the country which has granted approval⁽¹⁾;
- 4.2.1.2. the approval number prescribed in paragraph 4.1.4 above;
- 4.2.2. the following additional symbol or symbols:
 - 4.2.2.1. on headlamps meeting left-hand traffic requirements only, a horizontal arrow pointing to the right of an observer facing the headlamp, i.e. to the side of the road on which the traffic moves;
 - 4.2.2.2. on headlamps designed to meet the requirements of both traffic systems by means of an appropriate adjustment of the setting of the optical unit or the light source, a horizontal arrow with a head at each end, the heads pointing respectively to the left and to the right;
 - 4.2.2.3. on headlamps meeting the requirements of this Regulation in respect of the passing beam only, the letter 'DC';
 - 4.2.2.4. on headlamps meeting the requirements of this Regulation in respect of the driving beam only, the letter 'DR';
 - 4.2.2.5. on headlamps meeting the requirements of this Regulation in respect of both the passing beam and the driving beam, the letters 'DCR';
 - 4.2.2.6. on headlamps incorporating a lens of plastic material, the letters 'PL' to be affixed near the symbols prescribed in paragraphs 4.2.2.3 to 4.2.2.5 above;
 - 4.2.2.7. on headlamps meeting the requirements of this Regulation in respect of the driving beam, an indication of the maximum luminous intensity expressed by a reference mark as defined in paragraph 6.3.2.2 below, placed near the circle surrounding the letter 'E';

In the case of reciprocally incorporated headlamps, indication of the maximum luminous intensity of the driving beam as a whole shall be expressed as above.

- 4.2.3. In every case the relevant operating mode used during the test procedure according to paragraph 1.1.1.1 of annex 4 and the allowed voltage(s) according to paragraph 1.1.1.2 of annex 4 shall be stipulated on the approval forms and on the communication forms transmitted to the countries which are Contracting Parties to the Agreement and which apply this Regulation.

In the corresponding cases the device shall be marked as follows:

- 4.2.3.1. On headlamps meeting the requirements of this Regulation which are so designed that the passing beam shall not be lit simultaneously with that of any other lighting function with which it may be reciprocally incorporated: an oblique stroke (/) shall be placed behind the passing lamp symbol in the approval mark.

⁽¹⁾ 1 for Germany, 2 for France, 3 for Italy, 4 for the Netherlands, 5 for Sweden, 6 for Belgium, 7 for Hungary, 8 for the Czech Republic, 9 for Spain, 10 for Yugoslavia, 11 for the United Kingdom, 12 for Austria, 13 for Luxembourg, 14 for Switzerland, 15 (vacant), 16 for Norway, 17 for Finland, 18 for Denmark, 19 for Romania, 20 for Poland, 21 for Portugal, 22 for the Russian Federation, 23 for Greece, 24 (vacant), 25 for Croatia, 26 for Slovenia, 27 for Slovakia, 28 for Belarus, 29 for Estonia, 30 (vacant), 31 for Bosnia and Herzegovina, 32-36 (vacant) and 37 for Turkey. Subsequent numbers shall be assigned to other countries in the chronological order in which they ratify or accede to the Agreement concerning the Adoption of Uniform Conditions of Approval and Reciprocal Recognition of Approval for Motor Vehicle Equipment and parts, and the numbers thus assigned shall be communicated by the Secretary-General of the United Nations to the Contracting Parties to the Agreement.

- 4.2.4. The two digits of the approval number (at present 00) which indicate the series of amendments incorporating the most recent major technical amendments made to the Regulation at the time of issue of the approval and, if necessary, the required arrow may be marked close to the above additional symbols.
- 4.2.5. The marks and symbols referred to in paragraphs 4.2.1 and 4.2.2 shall be clearly legible and be indelible even when the headlamp is fitted in the vehicle. The displacement of a moving component is deemed to fulfil this requirement.
- 4.3. *Arrangement of the approval mark*
- 4.3.1. *I n d e p e n d e n t l a m p s*
- Annex 2, figures 1 to 9, to this Regulation give examples of arrangements of the approval marks with the above-mentioned additional symbols.
- 4.3.2. *G r o u p e d , c o m b i n e d o r r e c i p r o c a l l y i n c o r p o r a t e d l a m p s*
- 4.3.2.1. Where grouped, combined or reciprocally incorporated lamps have found to comply with the requirements of several Regulations, a single international approval mark may be affixed, consisting of a circle surrounding the letter 'E' followed by the distinguishing number of the country which has granted approval, and an approval number. This approval mark may be located anywhere on the grouped, combined or reciprocally incorporated lamps, provided that:
- 4.3.2.1.1. it is visible after their installation, even if displacement of a movable component is necessary;
- 4.3.2.1.2. no part of the grouped, combined or reciprocally incorporated lamps that transmits light can be removed without at the same time removing the approval mark.
- 4.3.2.2. The identification symbol for each lamp appropriate to each Regulation under which approval has been granted, together with the corresponding series of amendments incorporating the most recent major technical amendments to the Regulations at the time of issue of the approval and, if necessary, the required arrow shall be marked:
- 4.3.2.2.1. either on the appropriate light-emitting surface;
- 4.3.2.2.2. or in a group, in such a way that each of the grouped, combined or reciprocally incorporated lamps may be clearly identified (see four possible examples in annex 2, Figure 10).
- 4.3.2.3. The size of the components of a single approval mark shall not be less than the minimum size required by the Regulation under which approval has been granted for the smallest of the individual marks.
- 4.3.2.4. An approval number shall be assigned to each type approved. The same Contracting Party may not assign the same number to another type of grouped, combined or reciprocally incorporated lamps covered by this Regulation.
- 4.3.2.5. Annex 2, Figure 10 of this Regulation gives examples of arrangements of approval marks for grouped, combined or reciprocally incorporated lamps with all the above-mentioned additional symbols.

- 4.3.3. Lamps, the lens of which are used for different types of headlamps and which may be reciprocally incorporated or grouped with other lamps

The provisions laid down in paragraph 4.3.2 above are applicable.

- 4.3.3.1. In addition, where the same lens is used, the latter may bear the different approval marks relating to the different types of headlamps or units of lamps, provided that the main body of the headlamp, even if it cannot be separated from the lens, also comprises the space described in paragraph 3.2 above and bears the approval marks of the actual functions. If different types of headlamps comprise the same main body, the latter may bear the different approval marks.

- 4.3.3.2. Annex 2, Figure 11, to this Regulation gives examples of arrangements of approval marks relating to the above case.

B. TECHNICAL REQUIREMENTS FOR HEADLAMPS ⁽¹⁾

5. GENERAL SPECIFICATIONS

- 5.1. Each sample shall comply with the specifications set forth in paragraphs 6 to 8 below.

- 5.2. Headlamps shall be so made as to retain their prescribed photometric characteristics and to remain in good working order when in normal use, in spite of the vibrations to which they may be subjected.

- 5.2.1. Headlamps shall be fitted with a device enabling them to be so adjusted on the vehicle as to comply with the rules applicable to them. Such a device need not be fitted on units in which the reflector and the diffusing lens cannot be separated, provided the use of such units is confined to vehicles on which the headlamps setting can be adjusted by other means.

Where a headlamp providing a passing beam and a headlamp providing a driving beam, each equipped with its own light source(s), are assembled to form a composite unit, the adjusting device shall enable each optical system individually to be duly adjusted. The same provision applies to headlamps providing a front fog lamp beam and a driving beam, and to headlamps providing a passing beam and a front fog lamp beam, and to headlamps providing these three beams.

- 5.2.2. However, these provisions shall not apply to headlamp assemblies whose reflectors are indivisible. For this type of assembly, the requirements of paragraph 6.3 of this Regulation shall apply.

- 5.3. In the case when gas-discharge light source replacement can be carried out without tools, the lamp holder shall conform to the dimensional characteristics as given on the data sheet of IEC Publication 61-2, relevant to the category of gas-discharge light source used. The gas-discharge light source must fit easily into the headlamp.

- 5.4. Headlamps designed to satisfy the requirements of both right-hand and of left-hand traffic may be adapted for traffic on a given side of the road either by an appropriate initial setting when fitted on the vehicle or by selective setting by the user.

⁽¹⁾ Technical requirements gas-discharge light sources: see Regulation No 99.

Such initial or selective setting may consist, for example, of fixing either the optical unit at a given angle on the vehicle or the light source(s) at a given angle in relation to the optical unit. In all cases, only two different and clearly distinct settings, one for right-hand and one for left-hand traffic, shall be possible, and the design shall preclude inadvertent shifting from one setting to the other or setting in an intermediate position. Where two different setting positions are provided for the light source, the components for attaching the light source to the reflector must be so designed and made that, in each of its two settings, the light source will be held in position with the precision required for headlamps designed for traffic on only one side of the road. Conformity with the requirements of this paragraph shall be verified by visual inspection and, where necessary, by a test fitting.

- 5.5. On headlamps designed to provide alternately a driving beam and a passing beam, any mechanical, electro-mechanical or other device incorporated in the headlamp for switching from one beam to the other⁽¹⁾ must be so constructed that:
- 5.5.1. the device is strong enough to function 50 000 times without suffering damage despite the vibrations to which it may be subjected in normal use;
- 5.5.2. in the case of failure it is possible to obtain the passing beam automatically;
- 5.5.3. either the passing beam or the driving beam can always be obtained without any possibility of the mechanism stopping in between the two positions;
- 5.5.4. the user cannot, with ordinary tools, change the shape or position of the moving parts.
- 5.6. Complementary tests shall be done according to the requirements of annex 4 to ensure that in use there is no excessive change in photometric performance.
- 5.7. Light transmitting components made of plastic material shall be tested according to the requirements of annex 5.
- 5.8. The headlamp and ballast system shall not generate radiated or power line disturbances to cause a malfunction of other electric/electronic systems of the vehicle⁽²⁾.
6. ILLUMINATION
- 6.1. *General Provisions*
- 6.1.1. Headlamps shall be so made that with suitable gas-discharge light source they give adequate illuminance without dazzle when emitting the passing beam, and good illumination when emitting the driving beam.
- 6.1.2. The illumination produced by the headlamp shall be determined by means of a vertical screen set up 25 m forward of the headlamp and at right angles to its axes (see paragraph 6.2.6 and annex 3 to this Regulation), or by any equivalent photometric method.

⁽¹⁾ These provisions shall not apply to the control switch.

⁽²⁾ Compliance with the requirements for electromagnetic compatibility is relevant to the individual vehicle type.

- 6.1.3. The headlamp using a removable gas-discharge light source shall be deemed satisfactory if the photometric requirements set in the present paragraph 6 are met with one standard light source, which has been aged during at least 15 cycles, in accordance with annex 4, paragraph 4 of Regulation No 99. The flux of this gas-discharge light source may differ from the objective luminous flux specified in Regulation No 99. In this case, the illuminances shall be corrected accordingly.

This correction does not apply to headlamps using non removable gas-discharge light source, or to headlamps with the ballast(s) totally or partially integrated.

- 6.1.4. The dimensions determining the position of the arc inside the standard gas-discharge light source are shown in the relevant data sheet of Regulation No 99.

- 6.1.5. Photometric compliance must be checked in accordance with paragraph 6.2.6 or 6.3 of this Regulation. This is also valid for the cut off zone between 3°R and 3°L (measurement method for the cut-off colour being under consideration).

- 6.1.6. The trichromatic coordinates of the light of the beams emitted by headlamps using gas-discharge light sources must be in the following boundaries:

limit towards blue: $x \geq 0,310$

yellow: $x \leq 0,500$

green: $y \leq 0,150 + 0,640x$

green: $y \leq 0,440$

purple: $y \geq 0,050 + 0,750x$

red: $y \geq 0,382$

- 6.1.7. Four seconds after ignition of a headlamp which has not been operated for 30 minutes or more, 60 lux at least must be reached at point HV of a driving beam and 10 lux at point 50V of a passing beam for headlamps incorporating driving beam and passing beam functions, or 10 lux at point 50V for headlamps having only a passing beam function. The power supply shall be sufficient to secure the quick rise of the high current pulse.

6.2. *Provisions concerning passing beams*

- 6.2.1. The passing beam must produce a sufficiently sharp 'cut-off' to permit a satisfactory adjustment with its aid. The 'cut-off' must be a horizontal straight line on the side opposite to the direction of traffic for which the headlamp is intended; on the other side it must not extend either above the line HV/H2 of annex 3, Screen 1, or above the line HV/H3/H4 of annex 3, Screen 2. A cut-off extending above a combination of these lines shall in no circumstances be permitted.

- 6.2.2. The headlamp shall be so aimed that:

- 6.2.2.1. in the case of headlamps designed to meet the requirements of right-hand traffic, the 'cut-off' on the left-half of the screen⁽¹⁾ is horizontal and, in the case of headlamps designed to meet the requirements of left-hand traffic, the 'cut-off' on the right-half of the screen is horizontal;

⁽¹⁾ The test screen must be sufficiently wide to allow examination of the 'cut-off' over a range of at least 5° each side of the line VV.

- 6.2.2.2. this horizontal part of the 'cut-off' is situated on the screen 25 cm below the line HH (see annex 3). The kink of the elbow of the cut-off shall be on the VV line.
- 6.2.3. When so aimed, the headlamp needs, if its approval is sought solely for a passing beam, comply only with the requirements referred to in paragraphs 6.2.5 and 6.2.6 below; if it is intended to provide both a passing beam and a driving beam, it shall comply with the requirements set out in paragraphs 6.2.5 to 6.3.2.3. The values specified for Segment II in paragraph 6.2.6 do not apply to annex 3, Screen 2.
- 6.2.4. Where a headlamp so aimed does not meet the requirements set out in paragraphs 6.2.6 and 6.3, its alignment may be changed, provided that the axis of the beam is not displaced laterally by more than $0,50^\circ$ (= 22 cm) to the right or left and vertically not more than $0,2^\circ$ (= 8,7 cm) up or down⁽¹⁾. To facilitate alignment by means of the 'cut-off', the headlamp may be partially occulted in order to sharpen the 'cut-off'.
- 6.2.5. Only one gas-discharge light source is permitted for each passing beam headlamp.
- 6.2.5.1. The voltage applied to the terminals of the ballast(s) is:
- either: 13,5 V \pm 0,1 for 12 V systems
- or: otherwise specified (See annex 7)
- 6.2.6. After more than 10 minutes after ignition the illuminances produced on Screen 1 or 2 (or mirrored about the VV line for left-hand traffic) shall meet the following requirements:

Note: In the table:

Letter L means that the point or segment is located on the left of VV line.

Letter R means that the point or segment is located on the right of VV line.

Letter U means the point or segment is located above HH line.

Letter D means the point or segment is located below HH line.

Point or segments	Designation On and above line H/H2, or on and above line H/H3/H4	Illuminances (lux)	Horizontal Distances (cm)	Vertical Distances (cm)
		1 Max		
1	HV	1 max	0	0
2	B 50 L	0,5max	L 150	U 25
3	75 R	20 min	R 50	D 25
4	50 L	20 max	L 150	D 37,5
5	25 L1	30 max	L 150	D 75
6	50 V	12 min	0	D 37,5

⁽¹⁾ The limit of realignment of $0,5^\circ$ towards the right or left is not incompatible with upward or downward vertical realignment. The latter is limited, too, by the requirements of paragraph 6.3. However, the provisions of paragraph 6.3 are not applicable to headlamps intended to meet the requirements of this Regulation only for provision of a passing beam.

Point or segments	Designation On and above line H/H2, or on and above line H/H3/H4	Illuminances (lux)		
		1 Max	Horizontal Distances (cm)	Vertical Distances (cm)
7	50 R	20 min	R 75	D 37,5
8	25 L2	4 min	L 396	D 75
9	25 R1	4 min	R 396	D 75
10	25 L3	2 min	L 670	D 75
11	25 R2	2 min	R 670	D 75
12	15 L	1 min	L 910	D 125
13	15 R	1 min	R 910	D 125
14		(*)	L 350	U 175
15		(*)	0	U 175
16		(*)	R 350	U 175
17		(*)	L 175	U 87,5
18		(*)	0	U 87,5
19		(*)	R 175	U 87,5
20		0,1 min	L 350	0
21		0,2 min	L 175	0
A to B	Segment I	6 min	L 255 to R 225	D 37,5
C to D	Segment II	6 max	R 140 to R 396	U 45
E to F	Segment III and under	20 max	L 417 to R 375	D 187,5
	E max R	70 max	Right of VV line	Above D 75
	E max L	50 max	Left of VV line	

(*) The illumination values at points 14 through 19 shall be such that: $14 + 15 + 16 \geq 0,3$ lux and $17 + 18 + 19 \geq 0,6$ lux.

6.3. Provisions concerning driving beams

6.3.1. In the case of a headlamp designed to provide a driving beam and a passing beam, measurements of the illumination produced on the screen by the driving beam shall be taken with the same headlamp alignment as for measurements under paragraph 6.2.6 above; in the case of a headlamp providing a driving beam only, it shall be so adjusted that the area of maximum illumination is centred on the point of intersection of lines HH and VV; such a headlamp needs meet only the requirements referred to in paragraph 6.3. Test voltages are the same as in paragraph 6.2.5.1.

6.3.2. It is possible to use several light sources for the driving beam, these light sources being listed in either Regulation No 37 or Regulation No 99. The following provisions shall be met:

6.3.2.1. The point of intersection (HV) of the lines HH and VV shall be situated within the isolux representing 80 per cent of the maximum illuminance. This maximum illuminance, hereunder designated as Emax, shall lie between 70 and 180 lux.

6.3.2.2. The reference mark referred to in paragraph 4.2.2.7 above shall be obtained by means of the formula:

Reference mark = 0,208 Emax

This value shall be rounded off to the value: 17,5 — 20 — 25 — 27,5 — 30 — 37,5.

6.3.2.3. Starting from point HV, horizontally to the right and left, the illuminance shall be not less than 40 lux up to a distance of 1,125 m and not less than 10 lux up to a distance of 2,25 m.

6.4. The screen illuminance values mentioned in paragraphs 6.2.6 to 6.3.2.3 above shall be measured by means of a photo-receptor, the effective area of which shall be contained within a square of 65 mm side.

6.5. *Provisions concerning movable reflectors*

6.5.1. With the lamp fixed according to all the positions described in paragraph 2.1.4, the headlamp must meet the photometric requirements of paragraph 6.2 or 6.3, or both.

6.5.2. Additional tests are made after the reflector has been tilted vertically upwards by the angle quoted in paragraph 2.1.4 or 2 degrees, whichever is smaller, by means of the headlamp aiming devices. The headlamp is then re-aimed downwards (by means of the goniometer), and the photometric specifications must be met at the following points:

Passing beam: HV and 75 R (75 L respectively)

Driving beam: Emax, HV as percent of Emax

If the aiming devices do not allow a continuous movement, the position nearest to 2 degrees is chosen.

6.5.3. The reflector is brought back to its nominal angular position as defined in paragraph 6.2.2, and the goniometer is set back to its position of origin. The reflector is tilted vertically downwards by the angle quoted in paragraph 2.1.4, or 2 degrees, whichever is smaller, by means of the headlamp aiming device. The headlamp is then re-aimed upwards (by means of the goniometer for example) and points as in paragraph 6.5.2 are checked.

7. GAUGING OF DISCOMFORT

The discomfort caused by the passing beam of headlamps shall be gauged⁽¹⁾.

⁽¹⁾ This requirement will be the subject of a recommendation for the benefit of the administrations.

C. FURTHER ADMINISTRATIVE PROVISIONS**8. MODIFICATION OF THE HEADLAMP TYPE AND EXTENSION OF APPROVAL**

8.1. Every modification of the headlamp type including the ballast shall be notified to the administrative department which approved the headlamp type. The said department may then either:

8.1.1. Consider that the modifications made are unlikely to have appreciable adverse effects and that in any event the headlamp still complies with the requirements; or

8.1.2. Require a further test report from the technical service responsible for conducting the tests.

8.2. Confirmation or refusal or approval, specifying the alterations, shall be communicated by the procedure specified in paragraph 4.1.5 above to the Contracting Parties to the Agreement which apply this Regulation.

8.3. The competent authority issuing the extension of approval shall assign a series number to each communication form drawn up for such an extension and inform thereof the other Contracting Parties to the 1958 Agreement applying this Regulation by means of a communication form conforming to the model in annex 1 to this Regulation.

9. CONFORMITY OF PRODUCTION

9.1. Headlamps approved under this Regulation shall be so manufactured as to conform to the type approved by meeting the requirements set forth in paragraph 6.

9.2. In order to verify that the requirements of paragraph 9.1 are met, suitable controls of the production shall be carried out.

9.3. The holder of the approval shall in particular:

9.3.1. ensure the existence of procedures for the effective control of the quality of products:

9.3.2. have access to the control equipment necessary for checking the conformity to each approved type;

9.3.3. ensure that data of test results are recorded and that related documents shall remain available for a period to be determined in accordance with the administrative service;

9.3.4. analyze the results of each type of test in order to verify and ensure the stability of the product characteristics making allowance for variation of an industrial production;

9.3.5. ensure that for each type of product at least the tests prescribed in annex 8 to this Regulation are carried out;

- 9.3.6. ensure that any collecting of samples giving evidence of nonconformity with the type of test considered shall give rise to another sampling and another test. All the necessary steps shall be taken to re-establish the conformity of the corresponding production.
- 9.4. The competent authority which has granted type approval may at any time verify the conformity control methods applicable to each production unit.
- 9.4.1. In every inspection, the test books and production survey records shall be presented to the visiting inspector.
- 9.4.2. The inspector may take samples at random to be tested in the manufacturer's laboratory. The minimum number of samples may be determined in the light of results of the manufacturer's own checks.
- 9.4.3. When the quality level appears unsatisfactory or when it seems necessary to verify the validity of the tests carried out in the application of paragraph 9.4.2 above, the inspector shall select samples, to be sent to the technical service which has conducted the type approval tests, using the criteria of annex 9.
- 9.4.4. The competent authority may carry out any test prescribed in this Regulation. These tests will be on samples selected at random without causing distortion of the manufacturer's delivery commitments and in accordance with the criteria of annex 9.
- 9.4.5. The competent authority shall strive to obtain a frequency of inspection of once every two years. However, this is at the discretion of the competent authority and their confidence in the arrangements for ensuring effective control of the conformity of production. In the case where negative results are recorded, the competent authority shall ensure that all necessary steps are taken to re-establish the conformity of production as rapidly as possible.
- 9.5. Headlamps with apparent defects are disregarded.
- 9.6. The reference mark is disregarded.
- 9.7. The measuring points 14 to 21 from paragraph 6.2.6 of this Regulation are disregarded.
10. PENALTIES FOR NON-CONFORMITY OF PRODUCTION
- 10.1. The approval granted in respect of a type of headlamp pursuant to this Regulation may be withdrawn if the requirements are not complied with or if a headlamp bearing the approval mark does not conform to the type approved.
- 10.2. If a Contracting Party to the Agreement applying this Regulation withdraws an approval it has previously granted, it shall forthwith so notify the other Contracting Parties applying this Regulation by means of a communication form conforming to the model in annex 1 to this Regulation.

11. PRODUCTION DEFINITELY DISCONTINUED

If the holder of the approval completely ceases to manufacture a type of headlamp approved in accordance with this Regulation, he shall so inform the authority which granted the approval. Upon receiving the relevant communication, that authority shall inform thereof the other Contracting Parties to the 1958 Agreement applying this Regulation by means of a communication form conforming to the model in annex 1 to this Regulation.

12. NAMES AND ADDRESSES OF TECHNICAL SERVICES RESPONSIBLE FOR CONDUCTING APPROVAL TESTS, AND OF ADMINISTRATIVE DEPARTMENTS

The Contracting Parties to the 1958 Agreement applying this Regulation shall communicate to the United Nations Secretariat the names and addresses of the technical services responsible for conducting approval tests and of the administrative departments which grant approval and to which forms certifying approval or extension or refusal or withdrawal of approval, or production definitely discontinued, issued in other countries, are to be sent.

ANNEX I

Communication

[maximum format: A4 (210 x 297 mm)]



issued by: Name of administration:

.....
.....
.....

Concerning (2): APPROVAL GRANTED

APPROVAL EXTENDED

APPROVAL REFUSED

APPROVAL WITHDRAWN

PRODUCTION DEFINITELY DISCONTINUED

of a type of headlamp pursuant to Regulation No. 98

Approval No. Extension No.

- 1. Trade name or mark of the headlamp:
- 2. Manufacturer's name for the type of device:
- 3. Manufacturer's name and address:
- 4. If applicable, name and address of the manufacturer's representative:
- 5. Submitted for approval on:

(1) Distinguishing number of the country which has granted/extended/refused/withdrawn approval (see approval provisions in the Regulation).
 (2) Strike out what does not apply.

6. Technical service responsible for conducting approval tests:
7. Date of test report:
8. Number of test report:
9. Brief description:
- 9.1. Headlamp submitted for approval as type⁽¹⁾:
- 9.2. The passing beam light source may/may not⁽²⁾ be lit simultaneously with the driving beam light source and/or another reciprocally incorporated headlamp.
- 9.3. The rated voltage of the device is:
- 9.4. Category (or categories) of light source(s):
- 9.5. Trade name and identification number of separate ballast(s) or part(s) of ballast(s):
- 9.6. Remarks (if any):
10. Approval mark position:
11. Reason(s) for extension of approval:
12. Approval granted/extended/refused/withdrawn⁽²⁾:
13. Place:
14. Date:
15. Signature:
16. The list of documents deposited with the Administration Service which has granted approval is annexed to this communication and may be obtained on request.

(1) Indicate the appropriate marking selected from the list below:

DC	DC/D	C/PL	DR	DCR	DC/R	DC PL	DR PL	DCR PL
DC/R PL	DC	DCR	DC/R	DC/	DC PL	DCR PL	DC/R PL	
DC/PL	DC	DCR	DC/R	DC/	DCR PL	DC/R PL	DC/PL	
→	↔	↔	↔	↔	↔	↔	↔	↔

(2) Strike out what does not apply.

ANNEX 2

Examples of arrangements of approval marks

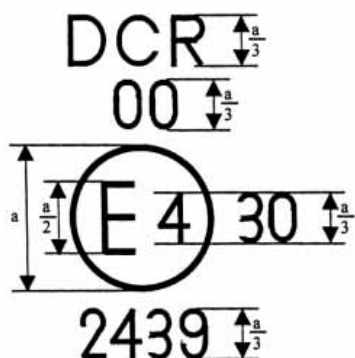

a = 8 mm min.

Figure 1

The headlamp bearing the approval mark shown above is a headlamp approved in the Netherlands (E4), under approval number 2439, meeting the requirements of this Regulation in its original form (00). The passing beam is designed for right-hand traffic only.

The figure 30 indicates that the maximum luminous intensity of the driving beam is between 86 250 and 101 250 candelas.

Note: The approval number and additional symbols shall be placed close to the circle and either above or below the letter 'E', or to the right or left of that letter. The digits of the approval number shall be on the same side of the letter 'E' and face in the same direction.

The use of Roman numerals as approval numbers should be avoided so as to prevent any confusion with other symbols.

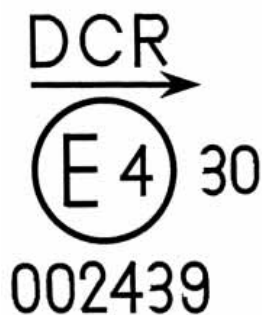

Figure 2

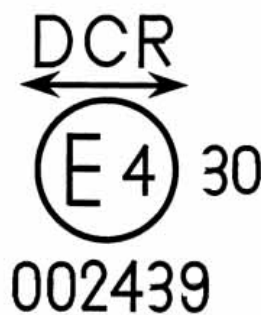

Figure 3a

The headlamp bearing the approval marking shown above is a headlamp meeting the requirements of this Regulation with respect to both the passing beam and the driving beam and designed:

For left-hand traffic only	For left-hand traffic only For both traffic systems, by means of an adjustment as desired of the setting of the optical unit or the light source on the vehicle
----------------------------	-----------------------------------------------------------------------------------------------------------------------------------------------------------------



Figure 3b



Figure 4



Figure 5

The headlamp bearing the approval marking shown above is a headlamp meeting the requirements of this Regulation in its original form with a gas discharge light source for the passing beam only and is equipped with a lens of plastic material, and designed:

For both traffic systems	For right-hand traffic only
--------------------------	-----------------------------

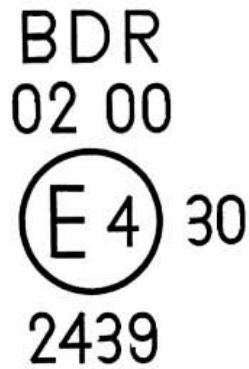

Figure 6

The headlamp bearing the approval marking shown above is a headlamp meeting the requirements of this Regulation in its original form with gas discharge light sources for the driving beam, and is combined or grouped or reciprocally incorporated with a front fog lamp.

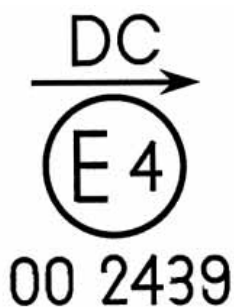

Figure 7a

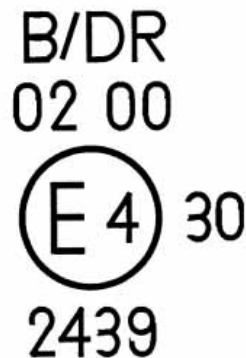

Figure 7b

The headlamp bearing the above approval marking shown above is a headlamp meeting the requirements of this Regulation.

With a gas discharge light source in respect of the passing beam only and is designed for left-hand traffic only	Same arrangement as figure 6, but the front fog lamp cannot be lit simultaneously with the driving beam
------------------------------------------------------------------------------------------------------------------	---------------------------------------------------------------------------------------------------------

DC/HR PL
00 04
ⓔ 4 30
2439

Figure 8

DC/PL
↔
ⓔ 4
00 2439

Figure 9

Identification of a passing beam headlamp meeting the requirements of this Regulation and incorporating a lens of plastic material.

and combined or grouped or reciprocally incorporated with R 8 halogen driving beam. The passing beam shall not be lit simultaneously with the halogen driving beam. The passing beam is designed for right-hand traffic only	designed for both traffic systems The passing beam shall not be lit simultaneously with another reciprocally incorporated headlamp
-------------------------------------------------------------------------------------------------------------------------------------------------------------------------------------------------------------------------------------	-------------------------------------------------------------------------------------------------------------------------------------------

Examples of possible simplified marking for grouped, combined or reciprocally incorporated lamps fitted to the front of the vehicle.

Figure 10

(The vertical and horizontal lines schematise the shape and overall arrangement of the light-signalling device. They are not part of the approval mark.)

Model A	ⓔ 1 30 17120		
	01 A →	↔ 00 DCR PL	02 B PL
			01 1a

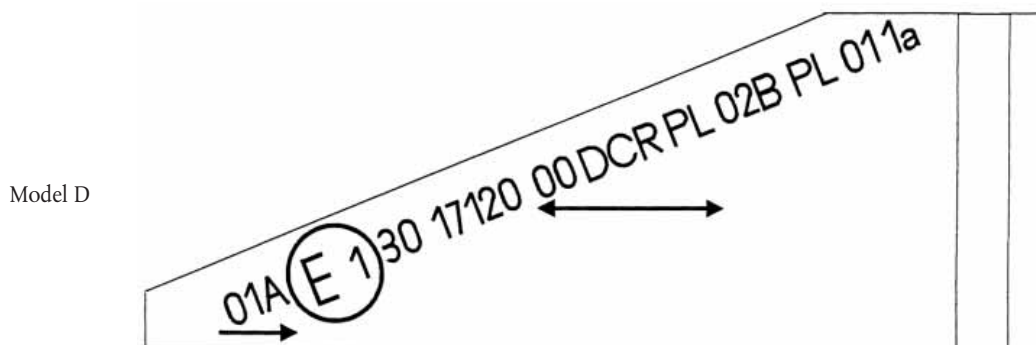
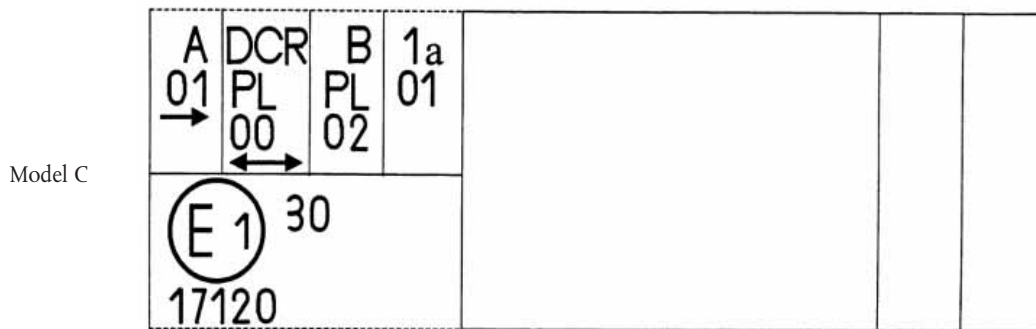
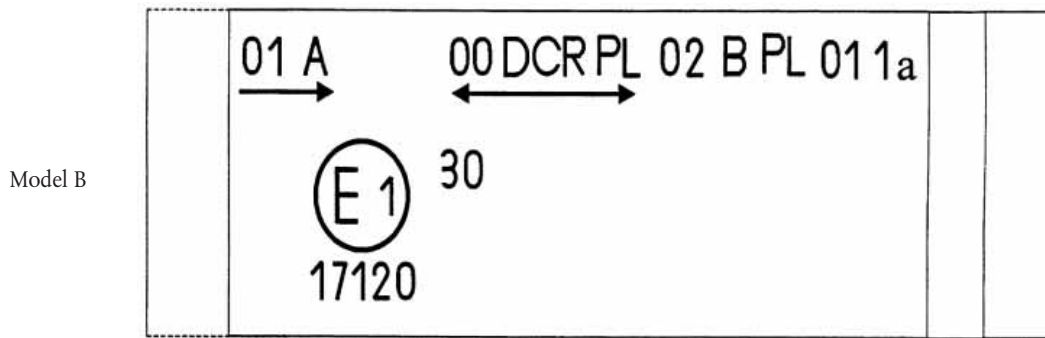

Note: The four examples shown above correspond to a lighting device bearing an approval mark relating to:

A front position lamp approved in accordance with the 01 series of amendments to Regulation No. 7, for left-hand installation;

a headlamp with a gas discharge passing beam designed for right-hand and left-hand traffic and a gas discharge driving beam with a maximum intensity comprised between 86 250 and 101 250 candelas (as indicated by the number 30), approved in accordance with this Regulation in its original form and incorporating a lens of plastic material;

a front fog lamp approved in accordance with the 02 series of amendments to Regulation No. 19 and incorporating a lens of plastic material;

a front direction indicator lamp of category 1a approved in accordance with the 01 series of amendments to Regulation No 6.

Figure 11

Lamp reciprocally incorporated or grouped with a headlamp

Example 1

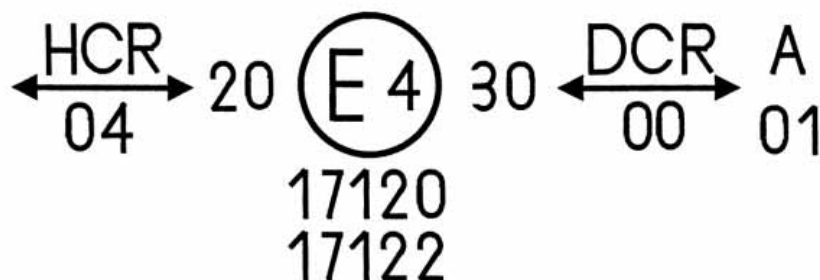

The above example corresponds to the marking of a lens intended to be used in different types of headlamps namely:

either: a headlamp with a passing beam designed for both traffic systems and a driving beam with a maximum luminous intensity comprised between 52 500 and 67 500 candelas (as indicated by the number 20) approved in the Netherlands (E 4) in accordance with the requirements of Regulation No 8 as amended by the 04 series of amendments, and a front position lamp approved in accordance with the 01 series of amendments to Regulation No 7,

or: a headlamp with a gas discharge passing beam and a driving beam with a maximum luminous intensity comprised between 86 250 and 101 250 candelas (as indicated by the number 30), designed for both traffic systems and approved in the Netherlands in accordance with the requirements of this Regulation in its original form, which is reciprocally incorporated with the same front position lamp as above,

or: even either of the above-mentioned headlamps approved as a single lamp.

The main body of the headlamp shall bear the only valid approval number, for instance:

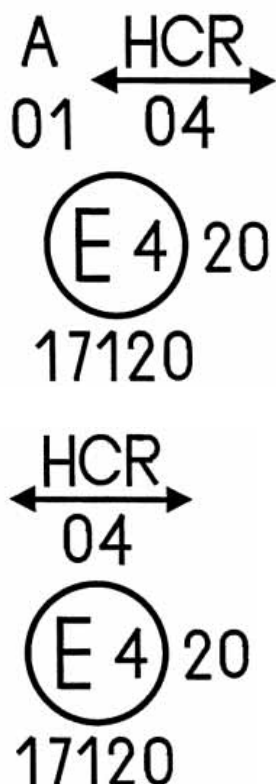

or

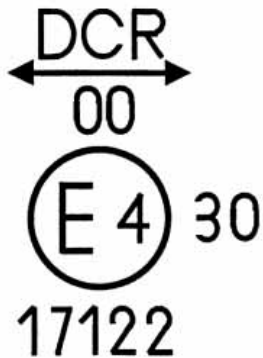

or

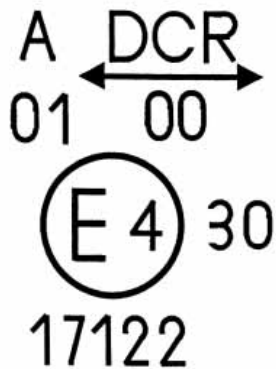
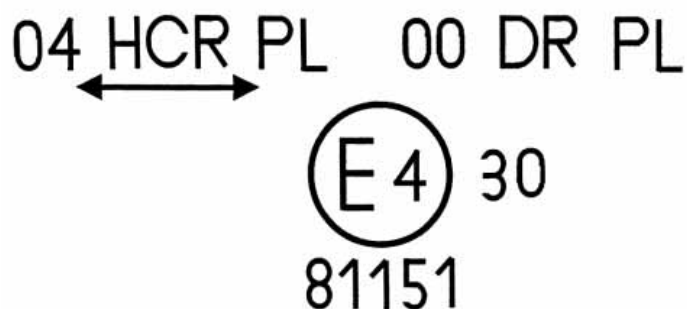

Figure 11 (following)

Example 2



The above example corresponds to the marking of a lens of plastic material and used in an assembly of two headlamps approved in the Netherlands (E4) under approval number 81151, consisting of:

a headlamp emitting a halogen passing beam designed for both traffic systems and a halogen driving beam with a maximum luminous intensity between x and y candelas, meeting the requirements of Regulation No 8 and,

a headlamp emitting a gas discharge driving beam with a maximum luminous intensity comprised between w and z candelas, meeting the requirements of this Regulation in its original form, the maximum luminous intensities of the driving beam contributors as a whole being comprised between 86 250 and 101 250 candelas as shown by the number 30.

ANNEX 3

Figure A: Measuring screen 1

* Do not scale.

Passing beam

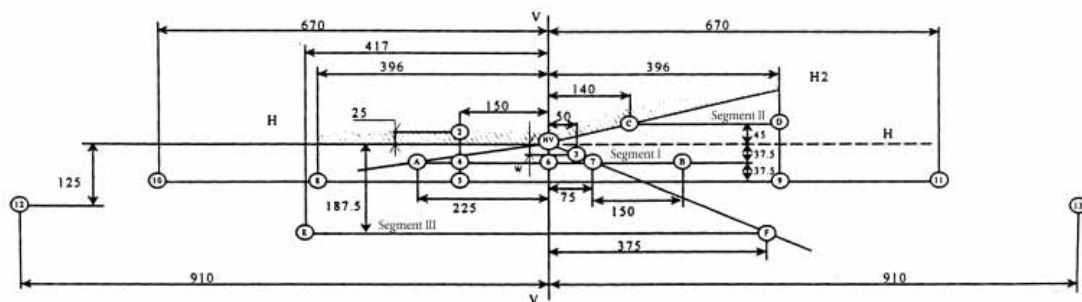

Dimensions are in cm on a flat vertical screen at 25 m. The HH and VV lines are the intersections with this screen of the horizontal and vertical planes passing through the axis of reference of the passing beam as declared by the applicant. The above screen describes a right-hand traffic passing beam. The screen for left-hand traffic passing beam is mirrored about the VV line. Angle HVH2-HH = 15°.

Figure B: Measuring screen 2

* Do not scale.

Passing beam

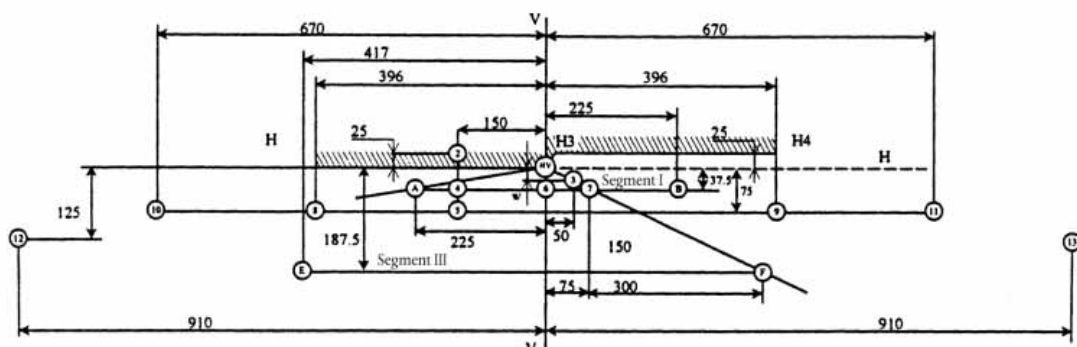

Dimensions are in cm on a flat vertical screen at 25 m. The HH and VV lines are the intersections with this screen of the horizontal and vertical planes passing through the axis of reference of the passing beam as declared by the applicant. The above screen describes a right-hand traffic passing beam. The screen for left-hand traffic passing beam is mirrored about the VV line. Angle HVH2-HH = 15°.

Figure C: Measuring points for illumination values

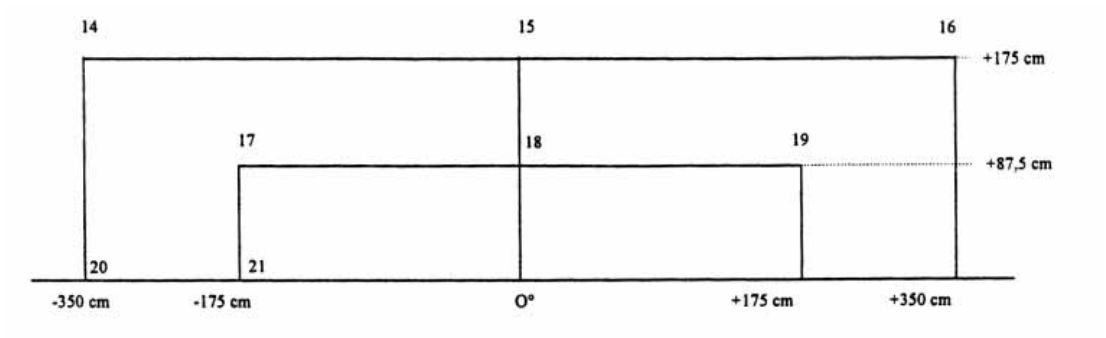

ANNEX 4

Tests for stability of photometric performance of headlamps in operation

TEST ON COMPLETE HEADLAMPS

Once the photometric values have been measured according to the prescriptions of this Regulation, in the point for E_{\max} for driving beam and in points HV, 50 R and B 50 L for passing beam (or HV, 50 L, B 50 R for headlamps designed for left-hand traffic) a complete headlamp sample shall be tested for stability of photometric performance in operation. 'Complete headlamp' shall be understood to mean the complete lamp itself including ballast(s) and those surrounding body parts and lamps which could influence its thermal dissipation.

1. TEST OF STABILITY OF PHOTOMETRIC PERFORMANCE

The tests shall be carried out in a dry and still atmosphere at an ambient temperature of $23\text{ °C} \pm 5\text{ °C}$, the complete headlamp being mounted on a base representing the correct installation on the vehicle.

1.1. *Clean headlamp*

The headlamp shall be operated for 12 hours as described in subparagraph 1.1.1 and checked as prescribed in subparagraph 1.1.2.

1.1.1. **Test Procedure**

The headlamp shall be operated for a period according to the specified time, so that:

- 1.1.1.1. a) in the case where only one lighting function (driving or passing beam) is to be approved, the corresponding light source is lit for the prescribed time⁽¹⁾
- b) in the case of a reciprocally incorporated passing beam lamp and driving beam lamp or in the case of a reciprocally incorporated front fog lamp and driving beam headlamp: If the applicant declares that the headlamp is to be used with a single light source lit⁽²⁾ at a time, the test shall be carried out in accordance with this condition, activating⁽¹⁾ each specified function successively for half the time specified in paragraph 1.1, in all other cases⁽¹⁾⁽²⁾ the headlamp shall be subjected to the following cycle until the time specified is reached:
- 15 minutes, passing beam lit
- 5 minutes, all functions lit;
- c) In the case of grouped lighting functions, all the individual functions shall be lit simultaneously for the time specified for individual lighting functions (a), also taking into account the use of reciprocally incorporated lighting functions (b), according to the manufacturer's specifications.

1.1.1.2. **Test voltage**

The test voltage for the ballast is $13,5 \pm 0,1$ volts for 12 V network system, or otherwise specified in the application for approval. If there are reciprocally incorporated filament lamps, the voltage producing the reference flux shall be used.

⁽¹⁾ When the tested headlamp is grouped and/ or reciprocally incorporated with signalling lamps, the latter shall be lit for the duration of the test. In the case of a direction indicator lamp, it shall be lit in flashing operation mode with an on/ off time ratio of approximately one to one.

⁽²⁾ Should two or more light sources be simultaneously lit when headlamp flashing is used, this shall not be considered as being normal use of the light sources simultaneously.

1.1.2. Test results

1.1.2.1. **Visual inspection**

Once the headlamp has been stabilised to the ambient temperature, the headlamp lens and the external lens, if any, shall be cleaned with a clean, damp cotton cloth. It shall then be inspected visually; no distortion, deformation, cracking or change in colour of either the headlamp lens or the external lens, if any, shall be noticeable.

1.1.2.2. **Photometric test**

To comply with the requirements of this Regulation, the photometric values shall be verified in the following points:

Passing beam: 50 R - B 50 L - HV for headlamps designed for right-hand traffic

50 L - B 50 R - HV for headlamps designed for left-hand traffic,

Driving beam: Point of Emax.

Another aiming may be carried out to allow for any deformation of the headlamp base due to heat (the change of the position of the cut-off line is covered in paragraph 2 of this annex).

A 10 per cent discrepancy between the photometric characteristics and the values measured prior to the test is permissible including the tolerances of the photometric procedure.

1.2. *Dirty headlamp*

After being tested as specified in subparagraph 1.1 above, the headlamp shall be operated for one hour as described in subparagraph 1.1.1, after being prepared as prescribed in subparagraph 1.2.1, and checked as prescribed in subparagraph 1.1.2.

1.2.1. Preparation of the headlamp

1.2.1.1. **Test mixture**

1.2.1.1.1. For headlamp with the outside lens in glass:

The mixture of water and a polluting agent to be applied to the headlamp shall be composed of:

9 parts by weight of silica sand with a particle size of 0-100 µm,

1 part by weight of vegetal carbon dust (beechwood) with a particle size of 0-100 µm,

0,2 parts by weight of NaCMC⁽¹⁾, and

an appropriate quantity of distilled water, with a conductivity of ≤ 1 mS/m.

The mixture must not be more than 14 days old.

1.2.1.1.2. For headlamp with outside lens in plastic material:

The mixture of water and polluting agent to be applied to the headlamp shall be composed of:

9 parts by weight of silica sand with a particle size of 0-100 µm,

1 part by weight of vegetal carbon dust (beechwood) with a particle size of 0-100 µm,

0,2 part by weight of NaCMC⁽¹⁾,

⁽¹⁾ NaCMC represents the sodium salt of carboxymethylcellulose, customarily referred to as CMC. The NaCMC used in the dirt mixture shall have a degree of substitution (DS) of 0,6-0,7 and a viscosity of 200-300 cP for a 2 per cent solution at 20 °C.

13 parts by weight of distilled water with a conductivity of ≤ 1 mS/m,

and

2 ± 1 parts by weight of surface-actant⁽¹⁾

The mixture must not be more than 14 days old.

1.2.1.2. **Application of the test mixture to the headlamp**

The test mixture shall be uniformly applied to the entire light-emitting surface of the headlamp and then left to dry. This procedure shall be repeated until the illuminating value has dropped to 15-20 per cent of the values measured for each following point under the conditions described in this annex:

Point Emax in passing beam/driving beam and in driving beam only,

50 R and 50 V⁽²⁾ for a passing lamp only, designed for right-hand traffic,

50 L and 50 V⁽²⁾ for a passing lamp only, designed for left-hand traffic.

1.2.1.3. **Measuring equipment**

The measuring equipment shall be equivalent to that used during headlamp approval tests. The gas-discharge light source supplied by the applicant shall be used for the photometric verification.

2. TEST FOR CHANGE IN VERTICAL POSITION OF THE CUT-OFF LINE UNDER THE INFLUENCE OF HEAT.

This test consists of verifying that the vertical drift of the cut-off line under the influence of heat does not exceed a specified value for an operating passing lamp. The headlamp tested in accordance with paragraph 1 shall be subjected to the test described in paragraph 2.1, without being removed from or readjusted in relation to its test fixture. If the headlamp has a moving reflector, only the position closest to the average vertical angular stroke is chosen for this test.

2.1. *Test for passing beam headlamps*

The test shall be carried out in a dry and still atmosphere at an ambient temperature of $23\text{ °C} \pm 5\text{ °C}$.

Using a mass production gas-discharge light source which has been aged for at least 15 hours, the headlamp shall be operated on passing beam function without being dismounted from or readjusted in relation to its test fixture. (For the purpose of this test, the voltage shall be adjusted as specified in paragraph 1.1.1.2). The position of the cut-off line in its horizontal part (between VV and the vertical line passing through point B 50 L for right-hand traffic or B 50 R for left-hand traffic) shall be verified 3 minutes (r_3) and 60 minutes (r_{60}) respectively after operation. The measurement of the variation in the cut-off line position as described above shall be carried out by any method giving acceptable accuracy and reproducible results.

2.2. *Test results*

2.2.1. The result expressed in milliradians (mrad) shall be considered as acceptable for a passing beam headlamp when the absolute value $\Delta r_1 = (r_3 - r_{60})$ recorded on the headlamp is not more than 1,0 mrad ($\Delta r_1 \leq 1,0$ mrad).

⁽¹⁾ The tolerance on quantity is due to the necessity of obtaining a dirt that correctly spreads out on all the plastic lens.

⁽²⁾ 50 V is situated 375 mm below HV on the vertical line VV on the screen at 25m distance.

- 2.2.2. However, if this value is more than 1,0 mrad but not more than 1,5 mrad ($1,0 \text{ mrad} < \Delta r_1 \leq 1,5 \text{ mrad}$), a second headlamp shall be tested as described in paragraph 2.1, after being subjected three consecutive times to the cycle as described below, in order to stabilise the position of mechanical parts of the headlamp on a base representative of the correct installation on the vehicle:

Operation of the passing beam for one hour (the voltage shall be adjusted as specified in paragraph 1.1.1.2);

Period of rest for one hour.

The headlamp type shall be considered as acceptable if the mean value of the absolute values Δr_1 measured on the first sample and Δr_{11} measured on the second sample is not more than 1,0 mrad.

$[(\Delta r_1 + \Delta r_{11}) / 2 \leq 1,0 \text{ mrad}]$.

ANNEX 5

Requirements for lamps incorporating lenses of plastic material testing of lens or material samples and of complete lamps

1. GENERAL SPECIFICATIONS

- 1.1. The samples supplied pursuant to paragraph 2.2.4 of the Regulation shall satisfy the specifications indicated in paragraphs 2.1 to 2.5 below.
- 1.2. The two samples of complete lamps supplied pursuant to paragraph 2.2.3 of the Regulation and incorporating lenses of plastic material shall, with regard to the lens material, satisfy the specifications indicated in paragraph 2.6 below.
- 1.3. The samples of lenses of plastic material or samples of material shall be subjected, with the reflector to which they are intended to be fitted (where applicable), to approval tests in the chronological order indicated in table A reproduced in appendix 1 to this annex.
- 1.4. However, if the lamp manufacturer can prove that the product has already passed the tests prescribed in paragraphs 2.1 to 2.5 below, or the equivalent tests pursuant to another Regulation, those tests need not be repeated; only the tests prescribed in appendix 1, table B, shall be mandatory.
- 1.5. If the headlamps are designed for right-hand installation only, or for left-hand installation only, tests pursuant to this annex may be done on one sample only, at the choice of the applicant.

2. TESTS

2.1. *Resistance to temperature changes*2.1.1. *Tests*

Three new samples (lenses) shall be subjected to five cycles of temperature and humidity (RH = relative humidity) change in accordance with the following programme:

- 3 hours at $40\text{ °C} \pm 2\text{ °C}$ and 85-95 per cent RH;
- 1 hour at $23\text{ °C} \pm 5\text{ °C}$ and 60-75 per cent RH;
- 15 hours at $-30\text{ °C} \pm 2\text{ °C}$;
- 1 hour at $23\text{ °C} \pm 5\text{ °C}$ and 60-75 per cent RH;
- 3 hours at $80\text{ °C} \pm 2\text{ °C}$
- 1 hour at $23\text{ °C} \pm 5\text{ °C}$ and 60-75 per cent RH;

Before this test, the samples shall be kept at $23\text{ °C} \pm 5\text{ °C}$ and 60-75 per cent RH for at least four hours.

Note: The periods of one hour at $23\text{ °C} \pm 5\text{ °C}$ shall include the periods of transition from one temperature to another which are needed in order to avoid thermal shock effects.

2.1.2. Photometric measurements

2.1.2.1. Method

Photometric measurements shall be carried out on the samples before and after the test. These measurements shall be made using a standard lamp, at the following points:

- B 50 L and 50 R for the passing beam of a passing lamp or a passing/driving lamp (B 50 R and 50 L in the case of headlamps intended for left-hand traffic),
- Emax for the driving beam of a driving lamp or a passing/driving lamp.

2.1.2.2. Results

The variation between the photometric values measured on each sample before and after the test shall not exceed 10 per cent including the tolerances of the photometric procedure.

2.2. Resistance to atmospheric and chemical agents

2.2.1. Resistance to atmospheric agents

Three new samples (lenses or samples of material) shall be exposed to radiation from a source having a spectral energy distribution similar to that of a black body at a temperature between 5 500 and 6 000 K. Appropriate filters shall be placed between the source and the samples so as to reduce as far as possible radiations with wave lengths smaller than 295 nm and greater than 2 500 nm. The samples shall be exposed to an energetic illumination of $1\,200\text{ W/m}^2 \pm 200\text{ W/m}^2$ for a period such that the luminous energy that they receive is equal to $4\,500\text{ MJ/m}^2 \pm 200\text{ MJ/m}^2$. Within the enclosure, the temperature measured on the black panel placed on a level with the samples shall be $50\text{ }^\circ\text{C} \pm 5\text{ }^\circ\text{C}$. In order to ensure a regular exposure, the samples shall revolve around the source of radiation at a speed between 1 and $5 \pm t/\text{min}-1$.

The samples shall be sprayed with distilled water of conductivity lower than 1 mS/m at a temperature of $23\text{ }^\circ\text{C} \pm 5\text{ }^\circ\text{C}$, in accordance with the following cycle:

- spraying: 5 minutes;
- drying: 25 minutes.

2.2.2. Resistance to chemical agents

After the test described in paragraph 2.2.1 above and the measurement described in paragraph 2.2.3.1 below have been carried out, the outer face of the said three samples shall be treated as described in paragraph 2.2.2.2 with the mixture defined in paragraph 2.2.2.1 below.

2.2.2.1. Test mixture

The test mixture shall be composed of 61,5 per cent n-heptane, 12,5 per cent toluene, 7,5 per cent ethyl tetrachloride, 12,5 per cent trichloroethylene and 6 per cent xylene (volume per cent).

2.2.2.2. Application of the test mixture

Soak a piece of cotton cloth (as per ISO 105) until saturation with the mixture defined in paragraph 2.2.2.1 above and, within 10 seconds, apply it for 10 minutes to the outer face of the sample at a pressure of 50 N/cm^2 , corresponding to an effort of 100 N applied on a test surface of $14 \times 14\text{ mm}$.

During this 10-minute period, the cloth pad shall be soaked again with the mixture so that the composition of the liquid applied is continuously identical with that of the test mixture prescribed. During the period of application, it is permissible to compensate the pressure applied to the sample in order to prevent it from causing cracks.

2.2.2.3. **Cleaning**

At the end of the application of the test mixture, the samples shall be dried in the open air and then washed with the solution described in paragraph 2.3. (Resistance to detergents) at $23\text{ }^{\circ}\text{C} \pm 5\text{ }^{\circ}\text{C}$. Afterwards the samples shall be carefully rinsed with distilled water containing not more than 0,2 per cent impurities at $23\text{ }^{\circ}\text{C} \pm 5\text{ }^{\circ}\text{C}$ and then wiped off with a soft cloth.

2.2.3. **Results**

2.2.3.1. After the test of resistance to atmospheric agents, the outer face of the samples shall be free from cracks, scratches, chipping and deformation, and the mean variation in transmission $\Delta t = (T2 - T3)/T2$, measured on the three samples according to the procedure described in appendix 2 to this annex shall not exceed 0,020 ($\Delta t_m \leq 0,020$).

2.2.3.2. After the test of resistance to chemical agents, the samples shall not bear any traces of chemical staining likely to cause a variation of flux diffusion, whose mean variation $\Delta m = (T5 - T4)/T2$, measured on the three samples according to the procedure described in appendix 2 to this annex shall not exceed 0,020:

($\Delta m \leq 0,020$).

2.2.4. **Resistance to light source radiations**

The following test shall be done:

Flat samples of each light transmitting plastic component of the headlamp are exposed to the light of the gas-discharge light source. The parameters such as angles and distances of these samples shall be the same as in the headlamp. These samples shall have the same colour and surface treatment, if any, as the parts of the headlamp.

After 1 500 hours of continuous exposure, the calorimetric specifications of the transmitted light must be met with a new standard gas-discharge light source, and the surfaces of the samples shall be free of cracks, scratches, scalings or deformation.

2.3. *Resistance to detergents and hydrocarbons*

2.3.1. **Resistance to detergents**

The outer face of three samples (lenses or samples of material) shall be heated to $50\text{ }^{\circ}\text{C} \pm 5\text{ }^{\circ}\text{C}$ and then immersed for five minutes in a mixture maintained at $23\text{ }^{\circ}\text{C} \pm 5\text{ }^{\circ}\text{C}$ and composed of 99 parts distilled water containing not more than 0,02 per cent impurities and one part alkylaryl sulphonate. At the end of the test, the samples shall be dried at $50\text{ }^{\circ}\text{C} \pm 5\text{ }^{\circ}\text{C}$. The surface of the samples shall be cleaned with a moist cloth.

2.3.2. **Resistance to hydrocarbons**

The outer face of these three samples shall then be lightly rubbed for one minute with a cotton cloth soaked in a mixture composed of 70 per cent n-heptane and 30 per cent toluene (volume per cent), and shall then be dried in the open air.

2.3.3. **Results**

After the above two tests have been performed successively, the mean value of the variation in transmission $\Delta t = (T2 - T3)/T2$, measured on the three samples according to the procedure described in appendix 2 to this annex shall not exceed 0,010:

($\Delta t_m \leq 0,010$).

2.4. *Resistance to mechanical deterioration*

2.4.1. Mechanical deterioration method

The outer face of the three new samples (lenses) shall be subjected to the uniform mechanical deterioration test by the method described in appendix 3 to this annex.

2.4.2. Results

After this test, the variations:

in transmission: $\Delta t = (T2 - T3)/T2$

and in diffusion: $\Delta d = (T5 - T4)/T2$

shall be measured according to the procedure described in appendix 2 in the area specified in paragraph 2.2.4 above. The mean value of the three samples shall be such that:

$\Delta t_m \leq 0,100$

$\Delta d_m \leq 0,050.$

2.5. *Test of adherence of coatings, if any*

2.5.1. Preparation of the sample

A surface of 20 mm × 20 mm in area of the coating of a lens shall be cut with a razor blade or a needle into a grid of squares approximately 2 mm × 2 mm. The pressure on the blade or needle shall be sufficient to cut at least the coating.

2.5.2. Description of the test

Use an adhesive tape with a force of adhesion of 2 N/(cm of width) ± 20 per cent measured under the standardised conditions specified in appendix 4 to this annex. This adhesive tape, which shall be at least 25 mm wide, shall be pressed for at least five minutes to the surface prepared as prescribed in paragraph 2.5.1.

Then the end of the adhesive tape shall be loaded in such a way that the force of adhesion to the surface considered is balanced by a force perpendicular to that surface. At this stage, the tape shall be torn off at a constant speed of 1,5 m/s ± 0,2 m/s.

2.5.3. Results

There shall be no appreciable impairment of the gridded area. Impairments at the intersections between squares or at the edges of the cuts shall be permitted, provided that the impaired area does not exceed 15 per cent of the gridded surface.

2.6. *Tests of the complete headlamp incorporating a lens of plastic material*

2.6.1. Resistance to mechanical deterioration of the lens surface

2.6.1.1. Tests

The lens of lamp sample No 1 shall be subjected to the test described in paragraph 2.4.1 above.

2.6.1.2. **Results**

After the test, the results of photometric measurements carried out on the headlamp in accordance with this Regulation shall not exceed by more than 30 per cent the maximum values prescribed at points B 50 L and HV and not be more than 10 per cent below the minimum values prescribed at point 75 R (in the case of headlamps intended for left-hand traffic, the points to be considered are B 50 R, HV and 75 L).

2.6.2. **Test of adherence of coatings, if any**

The lens of lamp sample No 2 shall be subjected to the test described in paragraph 2.5 above.

Appendix 1

CHRONOLOGICAL ORDER OF APPROVAL TESTS

A. Tests on plastic materials (lenses or samples of material supplied pursuant to paragraph 2.2.4. of this Regulation)

Tests	Samples	Lenses or samples of material									Lenses				
		1	2	3	4	5	6	7	8	9	10	11	12	13	14
1.1.	Limited photometry (paragraph 2.1.2)												X	X	X
1.1.1.	Temperature change (paragraph 2.1.1)												X	X	X
1.1.2.	Limited photometry (paragraph 2.1.2)												X	X	X
1.2.1.	Transmission measurement	X	X	X	X	X	X	X	X	X					
1.2.2.	Diffusion measurement	X	X	X				X	X	X					
1.3.	Atmospheric agents (paragraph 2.2.1)	X	X	X											
1.3.1.	Transmission measurement	X	X	X											
1.4.	Chemical agents (paragraph 2.2.2)	X	X	X											
1.4.1.	Diffusion measurement	X	X	X											
1.5.	Detergents (paragraph 2.3.1)				X	X	X								
1.6.	Hydrocarbons (paragraph 2.3.2)				X	X	X								
1.6.1.	Transmission measurement				X	X	X								
1.7.	Deterioration (paragraph 2.4.1)							X	X	X					
1.7.1.	Transmission measurement							X	X	X					
1.7.2.	Diffusion measurement							X	X	X					
1.8.	Adherence (paragraph 2.5)														X
1.9.	Resistance to light source radiations (paragraph 2.2.4)										X				

B. Tests on complete headlamps (supplied pursuant to paragraph 2.2.3 of this Regulation)

Tests	Complete headlamp	Sample No	
		1	2
		2.1.	Deterioration (paragraph 2.6.1.1)
2.2.	Photometry (paragraph 2.6.1.2)	X	
2.3.	Adherence (paragraph 2.6.2)		X

Appendix 2

METHOD OF MEASUREMENT OF THE DIFFUSION AND TRANSMISSION OF LIGHT

1. EQUIPMENT (see figure)

The beam of a collimator K with a half divergence $\beta/2 = 17,4 \times 10^{-4}$ rd is limited by a diaphragm DT with an opening of 6 mm against which the sample stand is placed.

A convergent achromatic lens L2, corrected for spherical aberrations, links the diaphragm DT with the receiver R; the diameter of the lens L2 shall be such that it does not diaphragm the light diffused by the sample in a cone with a half top angle of $\beta/2 = 14^\circ$.

An annular diaphragm DD with angles $\alpha/2 = 1^\circ$ and $\alpha \text{ max}/2 = 12^\circ$ is placed in an image focal plane of the lens L2.

The non-transparent central part of the diaphragm is necessary in order to eliminate the light arriving directly from the light source. It shall be possible to remove the central part of the diaphragm from the light beam in such a manner that it returns exactly to its original position.

The distance L2 DT and the focal length $F2^{(1)}$ of the lens L2 shall be so chosen that the image of DT completely covers the receiver R.

When the initial incident flux is referred to 1 000 units, the absolute precision of each reading shall be better than 1 unit.

2. MEASUREMENTS

The following readings shall be taken:

Reading	With sample	With central part of DD	Quantity represented
T1	No	No	Incident flux in initial reading
T2	Yes (before test)	No	Flux transmitted by the new material in a field of 24°
T3	Yes (before test)	No	Flux transmitted by the tested material in a field of 24°
T4	Yes (before test)	Yes	Flux diffused by the new material
T5	Yes (before test)	Yes	Flux diffused by the tested material

⁽¹⁾ For L2 it is recommended to use a focal distance of about 80 mm.

Figure 1

Optical setup for measurement of variations in diffusion and transmission

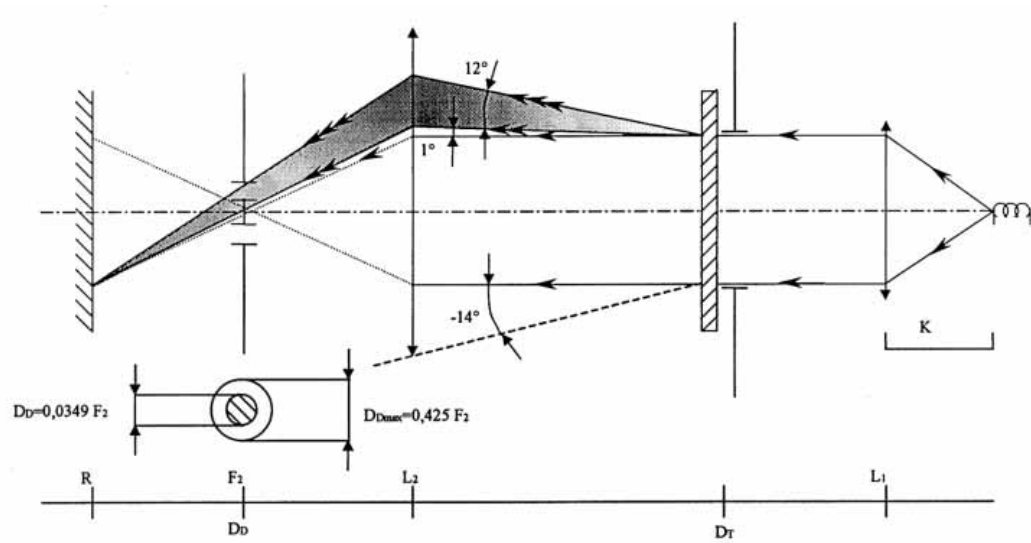

Appendix 3

SPRAY TESTING METHOD

1. TEST EQUIPMENT

1.1. *Spray gun*

The spray gun used shall be equipped with a nozzle 1.3 mm in diameter allowing a liquid flow rate of $0,24 \pm 0,02$ l/minute at an operating pressure of 6,0 bars $-0, + 0,5$ bar. Under these operation conditions the fan pattern obtained shall be $170 \text{ mm} \pm 50 \text{ mm}$ in diameter on the surface exposed to deterioration, at a distance of $380 \text{ mm} \pm 10 \text{ mm}$ from the nozzle.

1.2. *Test mixture*

The test mixture shall be composed of:

- Silica sand of hardness 7 on the Mohr scale, with a grain size between 0 and 0,2 mm and an almost normal distribution, with an angular factor of 1,8 to 2;
- Water of hardness not exceeding 205 g/m^3 for a mixture comprising 25 g of sand per litre of water.

2. TEST

The outer surface of the lamp lenses shall be subjected once or more than once to the action of the sand jet produced as described above. The jet shall be sprayed almost perpendicular to the surface to be tested.

The deterioration shall be checked by means of one or more samples of glass placed as a reference near the lenses to be tested. The mixture shall be sprayed until the variation in the diffusion of light on the sample or samples measured by the method described in appendix 2, is such that:

$$\Delta d = (T5 - T4)/T2 = 0,0250 \pm 0,0025.$$

Several reference samples may be used to check that the whole surface to be tested has deteriorated homogeneously.

Appendix 4

ADHESIVE TAPE ADHERENCE TEST

1. PURPOSE
This method allows to determine under standard conditions the linear force of adhesion of an adhesive tape to a glass plate.
2. PRINCIPLE
Measurement of the force necessary to unstick an adhesive tape from a glass plate at an angle of 90°.
3. SPECIFIED ATMOSPHERIC CONDITIONS
The ambient conditions shall be at 23 °C ± 5 °C and 65 ± 15 per cent relative humidity (RH).
4. TEST PIECES
Before the test, the sample roll of adhesive tape shall be conditioned for 24 hours in the specified atmosphere (see para 3 above).
Five test pieces each 400 mm long shall be tested from each roll. These test pieces shall be taken from the roll after the first three turns were discarded.
5. PROCEDURE
The test shall be under the ambient conditions specified in paragraph 3.
Take the five test pieces while unrolling the tape radially at a speed of approximately 300 mm/s, then apply them within 15 seconds in the following manner:
Apply the tape to the glass plate progressively with a slight lengthwise rubbing movement of the finger, without excessive pressure, in such a manner as to leave no air bubble between the tape and the glass plate.
Leave the assembly in the specified atmospheric conditions for 10 minutes.
Unstick about 25 mm of the test piece from the plate in a plane perpendicular to the axis of the test piece.
Fix the plate and fold back the free end of the tape at 90°. Apply force in such a manner that the separation line between the tape and the plate is perpendicular to this force and perpendicular to the plate.
Pull to unstick at a speed of 300 mm/s ± 30 mm/s and record the force required.
6. RESULTS
The five values obtained shall be arranged in order and the median value taken as the result of the measurement. This value shall be expressed in Newtons per centimetre of width of the tape.

ANNEX 6

Centre of reference

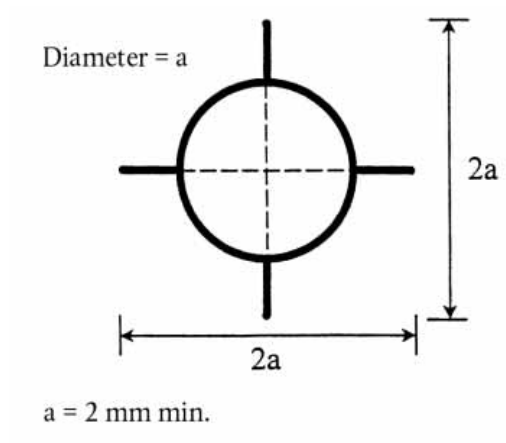

This optional mark of the centre of reference shall be positioned on the lens at its intersection with the reference axis of the passing beam, and also on the lenses of the driving beams when they are neither grouped nor combined nor reciprocally incorporated with a passing beam.

The above drawing represents the mark of the centre of reference as projected on a plane substantially tangent to the lens about the centre of the circle. The lines constituting this mark may either be solid or dotted.

—

ANNEX 7

Voltage markings

This marking must be placed on the main body of each headlamp containing only gas discharge light sources and ballast, and on each external part of the ballast.

The ballast(s) is(are) designed for a ** Volts network system.

This marking must be placed on the main body of each headlamp containing at least one gas discharge light source and ballast. The ballast(s) is(are) designed for a ** Volts network system.

None of the filament lamps which the headlamp contains is designed for a 24 Volts network system.

ANNEX 8

Minimum requirements for conformity of production control procedures

1. GENERAL
 - 1.1. The conformity requirements shall be considered satisfied from a mechanical and geometric standpoint, if the differences do not exceed inevitable manufacturing deviations within the requirements of this Regulation.
 - 1.2. With respect to photometric performance, the conformity of mass produced headlamps shall not be contested if, when testing photometric performance of any headlamp chosen at random and measured at $13,5 \text{ V} \pm 0,1 \text{ V}$ or as otherwise specified and:

either equipped with a removable standard gas-discharge light source according to paragraph 6.1.3. The luminous flux of this gas-discharge light source may differ from the reference luminous flux specified in Regulation No 99. In this case, the illuminances shall be corrected accordingly.

or equipped with the serial production gas-discharge light source and the serial ballast. The luminous flux of this light source may deviate from the nominal luminous flux due to light source and ballast tolerances as specified in Regulation No 99; accordingly the measured illuminances may be corrected by 20 per cent in the favourable direction.
 - 1.2.1. no illuminances value, if measured and corrected according to paragraph 1.2 above, deviates unfavourably by more than 20 per cent from the values prescribed in this Regulation. For values B 50 L (or R) and on line H/H2 (or H/H3/H4) and above, the maximum unfavourable deviation may be respectively:

B 50 L (or R)⁽¹⁾: 0,20 lx equivalent 20 per cent

0,30 lx equivalent 30 per cent

On line H/H2

(or line H/H3/H4)

and above: 0,30 lx equivalent 20 per cent

0,45 lx equivalent 30 per cent
 - 1.2.2. or if
 - 1.2.2.1. for the passing beam, the values prescribed in this Regulation are met at HV (with a tolerance of $\pm 0,2 \text{ lx}$) and related to that aiming at one point of each area delimited on the measuring screen (at 25 m) by a circle 15 cm in radius around points B 50 L (or R)⁽¹⁾ (with a tolerance of $+ 0,1 \text{ lx}$), 75 R (or L), 50 V, 25 R1, 25 L2, and on segment I;
 - 1.2.2.2. and if, for the driving beam, HV being situated within the isolux line 0.75 Emax, a tolerance of $+ 20$ per cent for maximum values and -20 per cent for minimum values is observed for the photometric values at any measuring point specified in paragraph 6.3 of this Regulation.
 - 1.2.3. If the results of the tests described above do not meet the requirements, the alignment of the headlamp may be changed, provided that the axis of the beam is not displaced laterally by more than $0,5^\circ$ to the right or left and not by more than $0,2^\circ$ up or down.

⁽¹⁾ Letters in brackets refer to headlamps intended for left-hand traffic.

1.2.4. If the results of the tests described above do not meet the requirements, tests on the headlamp shall be repeated using another standard gas-discharge light source or gas-discharge light source and ballast, whatever is applicable according to paragraph 1.2 above.

1.3. With respect to the verification of the change in vertical position of the cut-off line under the influence of heat, the following procedure shall be applied:

One of the sampled headlamps shall be tested according to the procedure described in paragraph 2.1 of annex 4 after being subjected three consecutive times to the cycle described in paragraph 2.2.2 of annex 4.

The headlamp shall be considered as acceptable if Δr (as defined in paragraphs 2.1 and 2.2 of annex 4 to this Regulation) does not exceed 1.5 mrad.

If this value exceeds 1.5 mrad but is not more than 2.0 mrad, a second headlamp shall be subjected to the test after which the mean of the absolute values recorded on both samples shall not exceed 1.5 mrad.

1.4. The chromaticity coordinates as specified in paragraph 6.1.6 of this Regulation shall be complied with.

2. MINIMUM REQUIREMENTS FOR VERIFICATION OF CONFORMITY BY THE MANUFACTURER

For each type of headlamp the holder of the approval mark shall carry out at least the following tests, at appropriate intervals. The tests shall be carried out in accordance with the provisions of this Regulation.

If any sampling shows non-conformity with respect to the type of test concerned, further samples shall be taken and tested. The manufacturer shall take steps to ensure the conformity of the production concerned.

2.1. *Nature of tests*

Tests of conformity in this Regulation shall cover the photometric characteristics and the verification of the change in vertical position of the cut-off line under the influence of heat.

2.2. *Methods used in tests*

2.2.1. Tests shall generally be carried out in accordance with the methods set out in this Regulation.

2.2.2. In any test of conformity carried out by the manufacturer, equivalent methods may be used with the consent of the competent authority responsible for approval tests. The manufacturer is responsible for proving that the applied methods are equivalent to those laid down in this Regulation.

2.2.3. The application of paragraphs 2.2.1 and 2.2.2 requires regular calibrations of test apparatus and its correlation with measurements made by a competent authority.

2.2.4. In all cases the reference methods shall be those of this Regulation, particularly for the purpose of administrative verification and sampling.

2.3. *Nature of sampling*

Samples of headlamps shall be selected at random from the production of a uniform batch. A uniform batch means a set of headlamps of the same type, defined according to the production methods of the manufacturer.

The assessment shall in general cover series production from individual factories. However, a manufacturer may group together records concerning the same type from several factories, provided these operate under the same quality system and quality management.

2.4. *Measured and recorded photometric characteristics*

The sampled headlamps shall be subjected to photometric measurements at the points provided for in the Regulation, the reading being limited to points Emax, HV⁽¹⁾, HL, HR⁽²⁾ in the case of the driving beam, and to points B 50 L (or R)⁽³⁾ HV, 50 V, 75 R (or L) and 25 L2 (or R2) in the case of the passing beam (see figure in annex 3).

2.5. *Criteria governing acceptability*

The manufacturer is responsible for carrying out a statistical study of the test results and for defining, in agreement with the competent authority, criteria governing the acceptability of his products in order to meet the specifications laid down for verification of conformity of products in paragraph 9.1 of this Regulation. The criteria governing the acceptability shall be such that, with a confidence level of 95 per cent, the minimum probability of passing a spot check in accordance with annex 9 (first sampling) would be 0,95.

⁽¹⁾ When the driving beam is reciprocally incorporated with the passing beam, HV in the case of the driving beam shall be the same measuring point as in the case of the passing beam.

⁽²⁾ HL and HR: point on 'hh' located at 1,125 m to the left and to the right of point HV respectively.

⁽³⁾ Letters in brackets refer to headlamps intended for left-hand traffic.

ANNEX 9

Minimum requirements for sampling by an inspector

1. GENERAL
 - 1.1. The conformity requirements shall be considered satisfied from a mechanical and a geometric standpoint, in accordance with the requirements of this Regulation, if any, if the differences do not exceed inevitable manufacturing deviations.
 - 1.2. With respect to photometric performance, the conformity of mass-produced headlamps shall not be contested if, when testing photometric performance of any headlamp chosen at random and measured at $13,5 \text{ V} \pm 0,1 \text{ V}$ or as otherwise specified and:
 - either equipped with a removable standard gas-discharge light source according to paragraph 6.1.3. The luminous flux of this gas-discharge light source may differ from the reference luminous flux specified in Regulation No 99. In this case, the illuminances shall be corrected accordingly.
 - or equipped with the serial production gas-discharge light source and the serial ballast. The luminous flux of this light source may deviate from the nominal luminous flux due to light source and ballast tolerances as specified in Regulation No 99, accordingly the measured illuminances may be corrected by 20 per cent in the favourable direction.
 - 1.2.1. no measured value deviates unfavourably by more than 20 per cent from the values prescribed in this Regulation. In the glare zone the maximum deviation may be respectively:
 - B 50 L (or R)⁽¹⁾: 0,20 lx equivalent 20 per cent
 - 0,30 lx equivalent 30 per cent
 - On line H/H2
 - (or line H/H3/H4)
 - and above: 0,30 lx equivalent 20 per cent
 - 0,45 lx equivalent 30 per cent
 - 1.2.2. or if:
 - 1.2.2.1. for the passing beam, the values prescribed in this Regulation are met at HV (with a tolerance of + 0,2 lx) and related to that aiming at one point of each area delimited on the measuring screen (at 25 m) by a circle of 15 cm in radius around points B 50 L (or R)⁽¹⁾ (with a tolerance of 0,1 lx), 75 R (or L), 50 V, 25 R1, 25 L2, and on segment I;
 - 1.2.2.2. and if, for the driving beam, HV being situated within the isolux $0,75 E_{\text{max}}$, a tolerance of + 20 per cent for maximum values and - 20 per cent for minimum values is observed for the photometric values at any measuring point specified in paragraph 6.3 of this Regulation. The reference mark is disregarded.
 - 1.2.3. If the results of the tests described above do not meet the requirements, the alignment of the headlamp may be changed, provided that the axis of the beam is not displaced laterally by more than $0,5^\circ$ to the right or left and not by more than $0,2^\circ$ up or down.

⁽¹⁾ Letters in brackets refer to headlamps intended for left-hand traffic.

- 1.2.4. If the results of the tests described above do not meet the requirements, tests on the headlamp shall be repeated using another standard gas-discharge light source or gas-discharge light source and ballast, whatever is applicable according to paragraph 1.2 above.
- 1.3. With respect to the verification of the change in vertical position of the cut-off line under the influence of heat, the following procedure shall be applied:
- One of the sampled headlamps shall be tested according to the procedure described in paragraph 2.1 of annex 4 after being subjected three consecutive times to the cycle described in paragraph 2.2.2 of annex 4.
- The headlamp shall be considered acceptable if Δr (as defined in paragraphs 2.1 and 2.2 of annex 4 to this Regulation) does not exceed 1,5 mrad.
- If this value exceeds 1,5 mrad but is not more than 2,0 mrad, a second headlamp shall be subjected to the test after which the mean of the absolute values recorded on both samples shall not exceed 1,5 mrad.
- 1.4. The chromaticity coordinates as specified in paragraph 6.1.6 of this Regulation shall be complied with.
2. FIRST SAMPLING
- In the first sampling four headlamps are selected at random. The first sample of two is marked A, the second sample of two is marked B.
- 2.1. The conformity is not contested
- 2.1.1. Following the sampling procedure shown in Figure 1 of this annex the conformity of mass-produced headlamps shall not be contested if the deviation of the measured values of the headlamps in the unfavourable directions are:
- 2.1.1.1. sample A
- A1: one headlamp 0 per cent
one headlamp not more than 20 per cent
- A2: both headlamps more than 0 per cent
but not more than 20 per cent
go to sample B
- 2.1.1.2. sample B
- B1: both headlamps 0 per cent
- 2.1.2. or if the conditions of paragraph 1.2.2 for sample A are fulfilled.
- 2.2. The conformity is contested.
- 2.2.1. Following the sampling procedure shown in Figure 1 of this annex the conformity of mass-produced headlamps shall be contested and the manufacturer requested to make his production meet the requirements (alignment) if the deviations of the measured values of the headlamps are:

- 2.2.1.1. sample A
- A3: one headlamp not more than 20 per cent
one headlamp more than 20 per cent
but not more than 30 per cent
- 2.2.1.2. sample B
- B2: in the case of A2 one headlamp more than 0 per cent
but not more than 20 per cent
one headlamp not more than 20 per cent
- B3: in the case of A2 one headlamp 0 per cent
one headlamp more than 20 per cent
but not more than 30 per cent
- 2.2.2. or if the conditions of paragraph 1.2.2 for sample A are not fulfilled.
- 2.3. *Approval withdrawn*
- Conformity shall be contested and paragraph 10 applied if, following the sampling procedure in Figure 1 of this annex, the deviations of the measured values of the headlamps are:
- 2.3.1. sample A
- A4: one headlamp not more than 20 per cent
one headlamp more than 30 per cent
- A5: both headlamps more than 20 per cent
- 2.3.2. sample B
- B4: in the case of A2 one headlamp more than 0 per cent
but not more than 20 per cent
one headlamp more than 20 per cent
- B5: in the case of A2 both headlamps more than 20 per cent
- B6: in the case of A2 one headlamp 0 per cent
one headlamp more than 30 per cent
- 2.3.3. or if the conditions of paragraph 1.2.2 for samples A and B are not fulfilled.
3. REPEATED SAMPLING
- In the cases of A3, B2, B3 a repeated sampling, third sample C of two headlamps and fourth sample D of two headlamps, selected from stock manufactured after alignment, is necessary within two months time after the notification.

- 3.1. The conformity is not contested.
- 3.1.1. Following the sampling procedure shown in Figure 1 of this annex the conformity of mass-produced headlamps shall not be contested if the deviations of the measured values of the headlamps are:
- 3.1.1.1. sample C
- C1: one headlamp 0 per cent
- one headlamp not more than 20 per cent
- C2: both headlamps more than 0 per cent
- but not more than 20 per cent
- go to sample D
- 3.1.1.2. sample D
- D1: in the case of C2 both headlamps 0 per cent
- 3.1.2. or if the conditions of paragraph 1.2.2 for sample C are fulfilled.
- 3.2. The conformity is contested.
- 3.2.1. Following the sampling procedure shown in Figure 1 of this annex the conformity of mass-produced headlamps shall be contested and the manufacturer requested to make his production meet the requirements (alignment) if the deviations of the measured values of the headlamps are:
- 3.2.1.1. sample D
- D2: in the case of C2 one headlamp more than 0 per cent
- but not more than 20 per cent
- one headlamp not more than 20 per cent
- 3.2.1.2. or if the conditions of paragraph 1.2.2 for sample C are not fulfilled.
- 3.3. *Approval withdrawn*
- Conformity shall be contested and paragraph 11 applied if, following the sampling procedure in Figure 1 of this annex, the deviations of the measured values of the headlamps are:
- 3.3.1. sample C
- C3: one headlamp not more than 20 per cent
- one headlamp more than 20 per cent
- C4: both headlamps more than 20 per cent

3.3.2. sample D

D3: in the case of C2

one headlamp 0 or more than 0 per cent

one headlamp more than 20 per cent

3.3.3. or if the conditions of paragraph 1.2.2 for samples C and D are not fulfilled.

4. CHANGE OF THE VERTICAL POSITION OF THE CUT-OFF LINE

With respect to the verification of the change in vertical positions of the cut-off line under the influence of heat, the following procedure shall be applied:

One of the headlamps of sample A after sampling procedure in Figure 1 of this annex shall be tested according to the procedure described in paragraph 2.1 of annex 4 after being subjected three consecutive times to the cycle described in paragraph 2.2.2 annex 4.

The headlamp shall be considered as acceptable if Δr does not exceed 1,5 mrad.

If this value exceeds 1,5 mrad but is not more than 2,0 mrad, the second headlamp of sample A shall be subjected to the test after which the mean of the absolute values recorded in both samples shall not exceed 1,5 mrad.

However, if this value of 1,5 mrad on sample A is not complied with, the two headlamps of sample B shall be subjected to the same procedure and the value of Δr for each of them shall not exceed 1,5 mrad.

Figure 1

