

ACTS ADOPTED BY BODIES CREATED BY INTERNATIONAL AGREEMENTS

Only the original UN/ECE texts have legal effect under international public law. The status and date of entry into force of this Regulation should be checked in the latest version of the UN/ECE status document TRANS/WP.29/343, available at:

<http://www.unece.org/trans/main/wp29/wp29wgs/wp29gen/wp29fdocstts.html>

Regulation No 34 of the Economic Commission for Europe of the United Nations (UNECE) — Uniform provisions concerning the approval of vehicles with regard to the prevention of fire risks [2016/1428]

Incorporating all valid text up to:

Supplement 1 to the 03 series of amendments — Date of entry into force 8 October 2016

CONTENTS

REGULATION

1. Scope
2. Application for approval
3. Approval
 - Part I — Approval of vehicles with regard to their fuel tanks
4. Definitions
5. Requirements for liquid fuel tanks
6. Tests of liquid fuel tanks
 - Part II-1 — Approval of vehicles with regard to the prevention of fire risks in the event of collision
 - Part II-2 — Approval of vehicle with regard to the prevention of fire risks in the event of rear collision
7. Definitions
8. Requirements for the installation of liquid fuel tanks
9. Tests on the vehicle
 - Part III — Approval of tanks for liquid fuel as separate technical units
10. Definitions
11. Requirements for liquid fuel tanks
 - Part IV — Approval of a vehicle with regard to the installation of an approved tank
12. Definitions
13. Requirements for the installation of liquid fuel tanks
14. Modifications of the type of vehicle or tank
15. Conformity of production

16. Penalties for non-conformity of production
17. Transitional provisions
18. Names and addresses of Technical Services conducting approval tests and of Type Approval Authorities

ANNEXES

- Annex 1 Appendix 1 — Communication concerning the approval or extension or refusal or withdrawal of approval or production definitively discontinued of a vehicle type with regard to the tank for liquid fuel and to the prevention of fire risks in the event of a frontal/lateral/rear collision and to a type of tank for liquid fuel pursuant to Regulation No 34
- Appendix 2 — Communication concerning the approval or extension or refusal or withdrawal of approval or production definitively discontinued of a fuel tank pursuant to Regulation No 34
- Annex 2 Arrangements of approval marks
- Annex 3 Frontal collision test against a barrier
- Annex 4 Procedure for rear-end collision test
- Annex 5 Testing of fuel tanks made of a plastic material
- Appendix 1 — Test of resistance to fire
- Appendix 2 — Dimensions and technical data of firebricks

1. SCOPE

This Regulation applies:

- 1.1. Part I: To the approval of vehicles of categories M, N and O ⁽¹⁾ with regard to the tank(s) for liquid fuel.
- 1.2. Part II-1: At the request of the manufacturer, to the approval of vehicles of categories M, N and O approved to Part I or IV of this Regulation fitted with liquid fuel tank(s) with regard to the prevention of fire risks in the event of a frontal and/or lateral collision as well as to the approval of vehicles of categories M₁ and N₁, which are of a total permissible mass exceeding 2,8 tonnes, and categories M₂, M₃, N₂, N₃ and O, fitted with tank(s) for liquid fuel, which have been approved to Part I or IV of this Regulation with regard to the prevention of fire risks in the event of a rear collision.

Part II-2: To the approval of vehicles of categories M₁ and N₁, which are of a total permissible mass not exceeding 2,8 tonnes, fitted with liquid fuel tank(s) approved to Part I or IV of this Regulation with regard to the prevention of fire risks in the event of a rear collision.
- 1.3. Part III: To the approval of tanks for liquid fuel as separate technical units.
- 1.4. Part IV: To the approval of vehicles with regard to the installation of approved tanks for liquid fuel.

2. APPLICATION FOR APPROVAL

- 2.1. Application for approval pursuant to Part I and/or Part II of this Regulation.
 - 2.1.1. The application for approval of a vehicle type to Part I or Part II of this Regulation shall be submitted by the vehicle manufacturer or by his duly accredited representative.

⁽¹⁾ As defined in the Consolidated Resolution on the Construction of Vehicles (R.E.3.), document ECE/TRANS/WP.29/78/Rev.3, para. 2 — www.unece.org/trans/main/wp29/wp29wgs/wp29gen/wp29resolutions.html

- 2.1.2. It shall be accompanied by the undermentioned documents in triplicate and by the following particulars:
- 2.1.2.1. A detailed description of the vehicle type with respect to the items specified in paragraph 4.2 and/or 7.2. The numbers and/or symbols identifying the engine type and the vehicle type shall be specified;
- 2.1.2.2. Drawing(s) showing the characteristics of the fuel tank and specifying the material from which it is made;
- 2.1.2.3. A diagram of the entire fuel feed systems, showing the site of each component on the vehicle; and
- 2.1.2.4. For application pursuant to Part II of this Regulation, a diagram of the electrical installation showing its siting and its mode of attachment to the vehicle.
- 2.1.3. The following shall be submitted to the technical service responsible for conducting the type-approval tests:
- 2.1.3.1. A vehicle representative of the vehicle type to be approved or the parts of the vehicle which the technical service deems necessary for approval tests;
- 2.1.3.2. In the case of a vehicle equipped with a tank made of a plastic material: seven additional tanks, with their accessories;
- 2.1.3.3. In the case of a vehicle equipped with a tank made of another material: two additional tanks, with their accessories.
- 2.2. Application for approval pursuant to Part III of this Regulation
- 2.2.1. The application for approval of a type of tank for liquid fuel pursuant to Part III of this Regulation shall be submitted by the tank manufacturer or by his duly accredited representative.
- 2.2.2. It shall be accompanied by the under-mentioned documents in triplicate and by the following particulars:
- 2.2.2.1. A detailed description of the type of fuel tank with respect to the items specified in paragraph 10.2; it should be specified whether the application applies to a type of tank with or without its accessories and whether it applies for a universal use or for a specific vehicle use. In the case of an approval of a type of tank without its accessories, clear identification of the accessories used for the tests shall be included;
- 2.2.2.2. Drawing(s) showing the characteristics of the fuel tank and specifying the material of which it is made and, in the case of a tank for specific vehicle use, characteristics of the vehicle parts used during the tests;
- 2.2.3. The following shall be submitted to the Technical Service responsible for conducting the type approval tests:
- 2.2.3.1. In the case of a tank made of plastic material: seven tanks, with their accessories. In the case of a tank to be approved without its accessories, seven sets of accessories of a type normally fitted to the vehicle shall be submitted;
- 2.2.3.2. In the case of a tank made of another material: two tanks, with their accessories. In the case of a tank to be approved without its accessories, two sets of accessories of a type normally fitted to the vehicle shall be submitted.
- 2.2.3.3. In the case of a tank made of plastic for a specific vehicle use, vehicle parts as indicated in paragraph 5.3.2 of Annex 5 shall be submitted.
- 2.3. Application for approval pursuant to Part IV of this Regulation
- 2.3.1. The application for approval of a type of vehicle pursuant to Part IV of this Regulation shall be submitted by the vehicle manufacturer or by his duly accredited representative.

- 2.3.2. It shall be accompanied by the below-mentioned documents in triplicate and by the following particulars:
- 2.3.2.1. A detailed description of the vehicle type with respect to the items specified in paragraph 12.2. The numbers and/or symbols identifying the engine type and the vehicle type shall be specified;
- 2.3.2.2. A diagram of the entire fuel feed system, showing the site of each component on the vehicle;
- 2.3.2.3. A list of all types of tanks for liquid fuel approved pursuant to Part III of this Regulation and intended to be fitted to the type of vehicle.
- 2.3.3. The following shall be submitted to the Technical Service responsible for conducting the type approval tests:
- 2.3.3.1. A vehicle representative of the type of vehicle to be approved;
- 2.3.3.2. If necessary, two additional tanks with their accessories in the case of each type of fuel tank approved without its accessories.
3. APPROVAL
- 3.1. Approval pursuant to Part I and/or Part II of this Regulation.
- 3.1.1. If the vehicle submitted for approval pursuant to this Regulation meets the requirements of Part I and/or Part II below, approval of that vehicle type shall be granted.
- 3.1.2. Each type approved shall be assigned an approval number whose first two digits shall constitute the number of the most recent series of amendments incorporated in the Regulation on the date of issue of the approval. A Contracting Party may however assign the same approval number to several vehicle types as defined in paragraph 4.2 and/or 7.2 if the types are variants of the same basic model and provided that each type is separately tested and found to comply with the conditions of this Regulation.
- 3.1.3. Notice of approval or of refusal of approval of a vehicle type pursuant to this Regulation shall be communicated to the Parties to the Agreement which apply this Regulation by means of a form conforming to the model in Annex 1, Appendix 1 to this Regulation and of drawings, giving the particulars referred to in paragraphs 2.1.2.2, 2.1.2.3 and 2.1.2.4 above (supplied by the applicant for approval) in a format not exceeding A 4 (210 × 297 mm) or folded to that format and on an appropriate scale.
- 3.1.4. There shall be affixed, conspicuously and in a readily accessible place specified on the approval form, to every vehicle conforming to a vehicle type approved under this Regulation, an international approval mark consisting of:
- 3.1.4.1. A circle surrounding the letter 'E' followed by the distinguishing number of the country which has granted approval ⁽¹⁾;
- 3.1.4.2. The number of this Regulation, followed by 'RI', if the vehicle is approved pursuant to Part I of the Regulation, or by 'RII-1' if the vehicle is approved pursuant to Parts I or IV and to Part II-1 of the Regulation, or by 'RII-2' if the vehicle is approved pursuant to Parts I or IV and to Part II-2 of the Regulation, a dash and the approval number to the right of the circle prescribed in paragraph 3.1.4.1.
- 3.1.5. If the vehicle conforms to a vehicle type approved, under one or more other Regulations annexed to the Agreement, in the country which has granted approval under this Regulation, the symbol prescribed in paragraph 3.1.4.1 need not be repeated; in such a case the additional numbers, approval numbers and symbols of all the Regulations under which approval has been granted in the country which has granted approval under this Regulation shall be placed in vertical columns to the right of the symbol prescribed in paragraph 3.1.4.1.
- 3.1.6. The approval mark shall be clearly legible and indelible.

⁽¹⁾ The distinguishing numbers of the Contracting Parties to the 1958 Agreement are reproduced in Annex 3 to the Consolidated Resolution on the Construction of Vehicles (R.E.3), document ECE/TRANS/WP.29/78/Rev. 3 — www.unece.org/trans/main/wp29/wp29wgs/wp29gen/wp29resolutions.html

- 3.1.7. The approval mark shall be placed close to or on the vehicle data plate affixed by the manufacturer.
- 3.1.8. Annex 2 to this Regulation gives examples of arrangements of the approval mark.
- 3.2. Approval pursuant to Part III of this Regulation
- 3.2.1. If the tank submitted for approval pursuant to this Regulation meets the requirements of Part III below, approval of that type of tank shall be granted.
- 3.2.2. Each type approved shall be assigned an approval number whose first two digits shall constitute the number of the most recent series of amendments incorporated in the Regulation on the date of issue of the approval.
- 3.2.3. Notice of approval or of refusal of approval of a type of tank pursuant to this Regulation shall be communicated to the Contracting Parties to the Agreement which apply this Regulation by means of a form conforming to the model in Annex 1, Appendix 2 to this Regulation and of drawings, giving the particulars referred to in paragraphs 2.2.2.1 and 2.2.2.2 above (supplied by the applicant for approval) in a format not exceeding A 4 (210 × 297 mm) or folded to that format and on an appropriate scale.
- 3.2.4. There shall be affixed, conspicuously and in a readily accessible place specified on the approval form, to every tank conforming to a type of tank approved under this Regulation, an international approval mark consisting of:
- 3.2.4.1. A circle surrounding the letter 'E' followed by the distinguishing number of the country which has granted approval ⁽¹⁾;
- 3.2.4.2. The number of this Regulation, followed by 'RIII', the mention 'U' if the tank is approved for a universal use or 'S' if the tank is approved for a specific vehicle use, the mention '+A' if the tank is approved with its accessories or '#A' if the tank is approved without its accessories, a dash and the approval number to the right of the circle prescribed in paragraph 3.2.4.1.
- 3.2.5. The approval mark shall be clearly legible and indelible when the tank is installed in the vehicle.
- 3.2.6. Annex 2 to this Regulation gives examples of arrangements of the approval mark.
- 3.3. Approval pursuant to Part IV of this Regulation
- 3.3.1. If the vehicle submitted for approval pursuant to this Regulation meets the requirements of Part IV below, approval of that vehicle type shall be granted.
- 3.3.2. Each type approved shall be assigned an approval number whose first two digits shall constitute the number of the most recent series of amendments incorporated in the Regulation on the date of issue of the approval. A Contracting Party may however assign the same approval number to several vehicle types as defined in paragraph 12.2 if the types are variants of the same basic model and provided that each type is separately tested and found to comply with the conditions of this Regulation.
- 3.3.3. Notice of approval or of refusal of approval of a vehicle type pursuant to this Regulation shall be communicated to the Contracting Parties to the Agreement which apply this Regulation by means of a form conforming to the model in Annex 1, Appendix 1 to this Regulation and of drawings, giving the particulars referred to in paragraphs 2.3.2.1, 2.3.2.2 and 2.3.2.3 above (supplied by the applicant for approval) in a format not exceeding A 4 (210 × 297 mm) or folded to that format and on an appropriate scale.
- 3.3.4. There shall be affixed, conspicuously and in a readily accessible place specified on the approval form, to every vehicle conforming to a vehicle type approved under this Regulation, an international approval mark consisting of:
- 3.3.4.1. A circle surrounding the letter 'E' followed by the distinguishing number of the country which has granted approval ⁽¹⁾;

⁽¹⁾ The distinguishing numbers of the Contracting Parties to the 1958 Agreement are reproduced in Annex 3 to the Consolidated Resolution on the Construction of Vehicles (R.E.3), document ECE/TRANS/WP.29/78/Rev. 3 — www.unece.org/trans/main/wp29/wp29wgs/wp29gen/wp29resolutions.html

- 3.3.4.2. The number of this Regulation, followed 'RIV', a dash and the approval number to the right of the circle prescribed in paragraph 3.3.4.1.
- 3.3.5. If the vehicle conforms to a vehicle type approved, under one or more other Regulations annexed to the Agreement, in the country which has granted approval under this Regulation, the symbol prescribed in paragraph 3.3.4.1 need not be repeated; in such a case the additional numbers, approval numbers and symbols of all the Regulations under which approval has been granted in the country which has granted approval under this Regulation shall be placed in vertical columns to the right of the symbol prescribed in paragraph 3.3.4.1.
- 3.3.6. The approval mark shall be clearly legible and indelible.
- 3.3.7. The approval mark shall be placed close to or on the vehicle data plate affixed by the manufacturer.
- 3.3.8. Annex 2 to this Regulation gives examples of arrangements of the approval mark.

PART I — APPROVAL OF VEHICLES WITH REGARD TO THEIR FUEL TANKS

4. DEFINITIONS

For the purposes of this Part of the Regulation:

- 4.1. 'Approval of a vehicle' means the approval of a vehicle type with regard to the liquid fuel tanks;
- 4.2. 'Vehicle type' means vehicles which do not differ in such essential respects as:
- 4.2.1. The manufacturer's type designation;
- 4.2.2. In vehicles of category M₁ ⁽¹⁾ the position of the tank(s) in the vehicle in so far as it has a negative effect on the requirements of paragraph 5.10;
- 4.3. 'Passenger compartment' means the space for occupant accommodation bounded by the roof, floor, side walls, doors, outside glazing, front bulkhead, and the plane of the rear compartment bulkhead or the plane of the rear seat back support;
- 4.4. 'Tank' means the tank(s) designed to contain the liquid fuel, as defined in paragraph 4.6, used primarily for the propulsion of the vehicle excluding its accessories (filler pipe, if it is a separate element, filler hole, cap, gauge, connections to the engine or to compensate interior excess pressure, etc.);
- 4.5. 'Capacity of the fuel tank' means the fuel tank capacity as specified by the manufacturer; and
- 4.6. 'Liquid fuel' means a fuel which is liquid in normal conditions of temperature and pressure.

5. REQUIREMENTS FOR LIQUID FUEL TANKS

- 5.1. Tanks shall be made so as to be corrosion-resistant.
- 5.2. Tanks shall satisfy, when equipped with all accessories, which are normally attached to them, the leakage tests carried out according to paragraph 6.1 at a relative internal pressure equal to double the working overpressure, but in any event not less than an overpressure of 30 kPa (0,3 bar).
- Tanks made of a plastic material are considered as meeting this requirement if they have passed the test described in Annex 5, paragraph 2.
- 5.3. Any excess pressure or any pressure exceeding the working pressure shall be compensated automatically by suitable devices (vents, safety valves, etc.).

⁽¹⁾ As defined in the Consolidated Resolution on the Construction of Vehicles (R.E.3.), document ECE/TRANS/WP.29/78/Rev.3, para. 2 — www.unece.org/trans/main/wp29/wp29wgs/wp29gen/wp29resolutions.html

- 5.4. The vents shall be designed in such a way as to prevent any fire risk. In particular, any fuel, which may leak when the tank(s) is (are) being filled shall not be able to fall on the exhaust system. It shall be channelled to the ground.
- 5.5. The tank(s) shall not be situated in, or form, a surface (floor, wall, bulkhead) of the passenger compartment or other compartment integral with it.
- 5.6. A partition shall be provided to separate the occupant compartment from the tank(s). The partition may contain apertures (e.g. to accommodate cables) provided they are so arranged that fuel cannot flow freely from the tank(s) into the occupant compartment or other compartment integral with it during normal conditions of use.
- 5.7. Every tank shall be securely fixed and so placed as to ensure that any fuel leaking from the tank or its accessories will escape to the ground and not into the occupant compartment during normal conditions of use.
- 5.8. The filler hole shall not be situated in the occupant compartment, in the luggage compartment or in the engine compartment.
- 5.9. The fuel shall not escape through the tank cap or through the devices provided to compensate excess pressure during the foreseeable course of operation of the vehicle. In the case of overturning of the vehicle, a drip may be tolerated provided that it does not exceed 30 g/min; this requirement shall be verified during the test prescribed in paragraph 6.2.
- 5.9.1. The fuel filler cap shall be fixed to the filler pipe.
- 5.9.1.1. The requirements of paragraph 5.9.1 shall be deemed to be satisfied if provision is made to prevent excess evaporative emissions and fuel spillage caused by a missing fuel filler cap.
- This may be achieved using one of the following:
- 5.9.1.1.1. An automatically opening and closing, non-removable fuel filler cap.
- 5.9.1.1.2. Design features which avoid excess evaporative emissions and fuel spillage in the case of a missing fuel filler cap,
- 5.9.1.1.3. Any other provision which has the same effect. Examples may include, but are not limited to, a tether filler cap, a chained filler cap or one utilising the same locking key for the filler cap and for the vehicle's ignition. In this case, the key shall be removable from the filler cap only in the locked condition. However, the use of tethered or chained filler cap by itself is not sufficient for vehicles other than those of categories M₁ and N₁.
- 5.9.2. The seal between the cap and the filler pipe shall be retained securely in place. The cap shall latch securely in place against the seal and filler pipe when closed.
- 5.10. Tanks shall be installed in such a way as to be protected from the consequences of a collision to the front or the rear of the vehicle; there shall be no protruding parts, sharp edges, etc. near the tank.
- 5.11. The fuel tank and its accessory parts shall be designed and installed in the vehicle in such a way that any ignition hazard due to static electricity shall be avoided.

If necessary, measure(s) for charge dissipation shall be provided. However, no charge dissipation system is required for fuel tanks designed for containing a fuel with a flash point of at least 55 °C as referred to in item 5.1 of the communication form in Annex 1, Appendix 2. Determination of the flash point shall be in accordance with ISO 2719:2002.

The manufacturer shall demonstrate to the Technical Service the measure(s) which guarantee the fulfilling of these requirements.

- 5.12. The fuel tank(s) shall be made of a fire-resistant metallic material. It (they) may be made of a plastic material provided the requirements of Annex 5 are complied with.

6. TESTS OF LIQUID FUEL TANKS

6.1. Hydraulic test

The tank shall be subjected to a hydraulic internal pressure test which shall be carried out on an isolated unit complete with all its accessories. The tank shall be completely filled with a non-flammable liquid (water, for example). After all communication with the outside has been cut off, the pressure shall be gradually increased, through the pipe connection through which fuel is fed to the engine, to a relative internal pressure equal to double the working pressure used and in any case to not less than an excess pressure of 30 kPa (0,3 bar), which shall be maintained for one minute. During this time the tank shell shall not crack or leak; however, it may be permanently deformed.

6.2. Overturn test

6.2.1. The tank and all its accessories shall be mounted on to a test fixture in a manner corresponding to the mode of installation on the vehicle for which the tank is intended: this also applies to systems for the compensation of the interior excess pressure.

6.2.2. The test fixture shall rotate about an axis lying parallel to the longitudinal vehicle axis.

6.2.3. The test shall be carried out with the tank filled to 90 per cent of its capacity and also 30 per cent of its capacity with a non-flammable liquid having a density and a viscosity close to those of the fuel normally used (water may be accepted).

6.2.4. The tank shall be turned from its installed position 90° to the right. The tank shall remain in this position for at least five minutes. The tank shall then be turned 90° further in the same direction. The tank shall be held in this position, in which it is completely inverted, for at least another five minutes. The tank shall be rotated back to its normal position. Testing liquid that has not flowed back from the venting system into the tank shall be drained and replenished if necessary. The tank shall be rotated 90° in the opposite direction and left for at least five minutes in this position.

The tank shall be rotated 90° further in the same direction. This completely inverted position shall be maintained for at least five minutes. Afterwards the tank shall be rotated back to its normal position.

The rotation rate for each successive increment of 90° shall take place in any time interval from 1 to 3 minutes.

PART II-1 — APPROVAL OF VEHICLES WITH REGARD TO THE PREVENTION OF FIRE RISKS IN THE EVENT OF COLLISION

7. DEFINITIONS

For the purposes of this Part of the Regulation:

7.1. 'Approval of a vehicle' means the approval of a vehicle type with regard to the prevention of fire risks;

7.2. 'Vehicle type' means vehicles which do not differ in such essential respects as:

7.2.1. The structure, shape, dimensions and materials (metal/plastic) of the tank(s);

7.2.2. In vehicles of category M₁ ⁽¹⁾ the position of the tank(s) in the vehicle in so far as it has a negative effect on the requirements of paragraph 5.10;

7.2.3. The characteristics and siting of the fuel feed system (pump, filters, etc.); and

⁽¹⁾ As defined in the Consolidated Resolution on the Construction of Vehicles (R.E.3.), document ECE/TRANS/WP.29/78/Rev.3, para. 2 — www.unece.org/trans/main/wp29/wp29wgs/wp29gen/wp29resolutions.html

- 7.2.4. The characteristics and siting of the electrical installation in so far as they have an effect on the results of the collision tests prescribed in this Regulation;
- 7.3. 'Transverse plane' means the vertical transverse plane perpendicular to the median longitudinal plane of the vehicle;
- 7.4. 'Unladen mass' means the mass of the vehicle in running order, unoccupied and unladen but complete with fuel, coolant, lubricants, tools and a spare wheel (if provided as standard equipment by the vehicle manufacturer);
8. REQUIREMENTS FOR THE INSTALLATION OF LIQUID FUEL TANKS
- 8.1. Fuel installation
- 8.1.1. The vehicles shall be approved according to either Part I or IV of this Regulation.
- 8.1.2. The components of the fuel installation shall be adequately protected by parts of the frame or bodywork against contact with possible obstacles on the ground. Such protection shall not be required if the components beneath the vehicle are further from the ground than the part of the frame or bodywork in front of them.
- 8.1.3. The pipes and all other parts of the fuel installation shall be accommodated on the vehicle at sites protected to the fullest possible extent. Twisting and bending movements, and vibrations of the vehicle's structure or drive unit, shall not subject the components of the fuel installation to friction, compression or any other abnormal stress.
- 8.1.4. The connections of pliable or flexible pipes with rigid parts of components of the fuel installation shall be so designed and constructed as to remain leak-proof under the various conditions of use of the vehicle, despite twisting and bending movements and despite vibrations of the vehicle's structure or drive unit.
- 8.1.5. If the filler hole is situated on the side of the vehicle, the filler cap shall not, when closed, project beyond the adjacent surfaces of the bodywork.
- 8.2. Electrical installation
- 8.2.1. Electric wires other than wires accommodated in hollow components shall be attached to the vehicle's structure or walls or partitions near which they lead. The points at which they pass through walls or partitions shall be satisfactorily protected to prevent cutting of the insulation.
- 8.2.2. The electrical installation shall be so designed, constructed and fitted that its components are able to resist the corrosion phenomena to which they are exposed.
9. TESTS ON THE VEHICLE
- In the frontal impact test against a barrier carried out by the procedure specified in Annex 3 to this Regulation, in the lateral impact test performed according to the procedure described in Annex 4 to Regulation No 95, 01 series of amendments, and in the rear-end impact test carried out by the procedure specified in Annex 4 hereto,
- 9.1. No more than a slight leakage of liquid in the fuel installation shall occur on collision;
- 9.2. If there is continuous leakage in the fuel installation after the collision, the rate-of leakage shall not exceed 30 g/min; if the liquid from the fuel installation mixes with liquids from the other systems, and if the several liquids cannot be easily separated and identified, the continuous leakage shall be evaluated from all the fluids collected;
- 9.3. No fire maintained by the fuel shall occur.
- 9.4. During and after the impacts described in paragraph 9 above, the battery shall be kept in position by its securing device.

- 9.5. At the request of the manufacturer, the frontal collision test set out in Annex 3 to this Regulation can be replaced by the test procedure described in Annex 3 to Regulation No 94, 01 series of amendments.

PART II-2 — APPROVAL OF VEHICLE WITH REGARD TO THE PREVENTION OF FIRE RISKS IN THE EVENT OF REAR COLLISION

- 9.6. Definitions and test requirements
- 9.6.1. Paragraphs 7 to 8.2.2 of Part II-1 shall apply.
- 9.6.2. The vehicle test shall be performed according to the procedures described in Annex 4 to this Regulation.
- 9.6.3. After the collision test, the performance requirements of paragraphs 9.1 to 9.4 of Part II-1 shall be met.

PART III — APPROVAL OF TANKS FOR LIQUID FUEL AS SEPARATE TECHNICAL UNITS

10. DEFINITIONS

For the purposes of this Part of the Regulation:

- 10.1. 'Tank' means the tank(s) designed to contain the liquid fuel, as defined in paragraph 10.3, used primarily for the propulsion of the vehicle; the tank may be approved either with or without its accessories (filler pipe, if it is a separate element, filler hole, cap, gauge, connections to compensate interior excess pressure, etc.);
- 10.2. 'Capacity of the fuel tank' means the fuel tank capacity as specified by the tank manufacturer;
- 10.3. 'Liquid fuel' means a fuel which is liquid in normal conditions of temperature and pressure;
- 10.4. 'Approval of a tank' means the approval of a type of liquid fuel tank;
- 10.5. 'Type of tank' means tanks which do not differ in such essential respects as:
- 10.5.1. The structure, shape, dimensions and material (metal/plastic) of the tank(s);
- 10.5.2. The intended use of the tank: universal use or specific vehicle use;
- 10.5.3. The presence or absence of the accessories.

11. REQUIREMENTS FOR LIQUID FUEL TANKS

- 11.1. The requirements stated in paragraphs 5.1, 5.2, 5.3, 5.9, 5.12, 6.1 and 6.2 above shall be complied with when the tanks are equipped with the accessories that are normally attached to them.
- 11.2. In case the tanks are to be approved without their accessories the manufacturer's documentation shall clearly identify the accessories used for the test.

PART IV — APPROVAL OF VEHICLES WITH REGARD TO THE INSTALLATION OF APPROVED FUEL TANK(S)

12. DEFINITIONS

For the purposes of this Part of the Regulation:

- 12.1. 'Approval of a vehicle' means the approval of a vehicle type with regard to the installation of liquid fuel tank(s) approved pursuant to Part III of this Regulation;

- 12.2. 'Vehicle type' means vehicles which do not differ in such essential respects as:
- 12.2.1. The manufacturer's type designation;
- 12.2.2. In vehicles of category M₁ ⁽¹⁾ the position of the tank(s) in the vehicle in so far as it has a negative effect on the requirements of paragraph 5.10;
13. REQUIREMENTS FOR THE INSTALLATION OF LIQUID FUEL TANKS
- 13.1. The requirements stated in paragraphs 5.4, 5.5, 5.6, 5.7, 5.8, 5.10, and 5.11 above shall be complied with.
- 13.2. In case the tanks are approved without their accessories, those accessories used during the tests on the tanks and identified in the manufacturer's documentation according to paragraph 11.2 above shall, at the request of the manufacturer, be included in the approval pursuant to Part IV of this Regulation. Additional accessories shall be included provided that the Technical Service is satisfied that the vehicle complies with the requirement of Parts III and IV of this Regulation.
14. MODIFICATIONS OF THE TYPE OF VEHICLE OR TANK
- 14.1. Every modification of the type of vehicle or tank shall be notified to the Type Approval Authority which approved the vehicle type. The Authority may then either:
- 14.1.1. Consider that the modifications made are unlikely to have appreciable adverse effects, and that in any case the vehicle still meets the requirements; or
- 14.1.2. Require a further test report from the Technical Service responsible for conducting the tests.
- 14.2. Without prejudice to the provisions of paragraph 14.1 above, a variant of the vehicle tested according to Part II of this Regulation whose unladen mass does not differ by more than ± 20 per cent from that of the approval-tested vehicle shall not be regarded as a modification of the vehicle type.
- 14.3. Notice of confirmation of approval or of refusal of approval, specifying the modifications shall be communicated by the procedure specified in paragraphs 3.1.3, 3.2.3 or 3.3.3 above to the Contracting Parties to the Agreement which apply this Regulation.
15. CONFORMITY OF PRODUCTION
- The conformity of production procedures shall comply with those set out in the Agreement, Appendix 2 (E/ECE/324-E/ECE/TRANS/505/Rev.2), with the following requirements:
- 15.1. Every vehicle or tank bearing an approval mark as prescribed under this Regulation shall conform to the vehicle type approved and satisfy the requirements of the respective Parts above.
- 15.2. In order to verify conformity as prescribed in paragraph 15.1 above, a sufficient number of serially-produced vehicles or tanks bearing the approval mark required by this Regulation shall be subjected to random checks.
- 15.3. As a general rule, the conformity of the vehicle or tank with the approved type shall be checked on the basis of the description given in the approval form and its annexes. However, the vehicle or tank shall if necessary be subjected to the checks prescribed in paragraph 6 above.
16. PENALTIES FOR NON-CONFORMITY OF PRODUCTION
- 16.1. The approval granted in respect of a type of vehicle or tank pursuant to this Regulation may be withdrawn if the requirement laid down in paragraph 15.1 above is not complied with or if the vehicle has failed to pass the checks prescribe in paragraph 9 above.
- 16.2. If a Contracting Party to the Agreement which applies this Regulation withdraws an approval it has previously granted, it shall forthwith notify the other Parties to the Agreement which apply this Regulation thereof by means of a copy of the communication form conforming to the model in Annex 1 or 2 to this Regulation.

⁽¹⁾ As defined in the Consolidated Resolution on the Construction of Vehicles (R.E.3.), document ECE/TRANS/WP.29/78/Rev.3, para. 2 — www.unece.org/trans/main/wp29/wp29wgs/wp29gen/wp29resolutions.html

17. TRANSITIONAL PROVISIONS

- 17.1. As from the official date of entry into force of the 02 series of amendments, no Contracting Party applying this Regulation shall refuse to grant ECE approval under this Regulation as amended by the 02 series of amendments.
- 17.2. As from 12 months after the date of entry into force of the 02 series of amendments, Contracting Parties applying this Regulation shall grant ECE approvals only if vehicle type to be approved meets the requirements of this Regulation as amended by the 02 series of amendments.
- 17.3. Until 12 months after the date of entry into force of the 02 series of amendments to this Regulation, no Contracting Party applying this Regulation shall refuse national type approval of a vehicle type approved to the preceding series of amendments to this Regulation.
- 17.4. Starting 24 months after the entry into force of the 02 series of amendments to this Regulation, Contracting Parties applying this Regulation may refuse first national registration (first entry into service) of a vehicle which does not meet the requirements of the 02 series of amendments to this Regulation.
- 17.5. As from the official date of entry into force of the Supplement 3 to the 02 series of amendments, no Contracting Party applying this Regulation shall refuse to grant ECE approval under this Regulation as amended by Supplement 3 to the 02 series of amendments.
- 17.6. Even after the entry into force of the Supplement 3 to the 02 series of amendments to this Regulation, approvals of the vehicles to the preceding supplements to the 02 series of amendments shall remain valid and Contracting Parties applying this Regulation shall continue to grant extensions to such approvals and shall continue to accept them.
- 17.7. As from the official date of entry into force of the 03 series of amendments, no Contracting Party applying this Regulation shall refuse to grant or refuse to accept type approvals under this Regulation as amended by the 03 series of amendments.
- 17.8. As from 1 September 2018, Contracting Parties applying this Regulation shall grant type approvals only if the vehicle type to be approved meets the requirements of this Regulation as amended by the 03 series of amendments.
- 17.9. Contracting Parties applying this Regulation shall not refuse to grant extensions of type approvals for existing types which have been granted according to the preceding series of amendments to this Regulation.
- 17.10. Even after the date of entry into force of the 03 series of amendments to this Regulation, Contracting Parties applying this Regulation shall continue to accept type approvals to the preceding series of amendments to the Regulation which are not affected by the 03 series of amendments.
- 17.11. Notwithstanding the transitional provisions above, Contracting Parties whose application of this Regulation comes into force after the date of entry into force of the most recent series of amendments are not obliged to accept type approvals which were granted in accordance with any of the preceding series of amendments to this Regulation.

18. NAMES AND ADDRESSES OF TECHNICAL SERVICES CONDUCTING APPROVAL TESTS, AND OF TYPE APPROVAL AUTHORITIES

The Contracting Parties to the Agreement which apply this Regulation shall communicate to the Secretariat of the United Nations the names and addresses of the Technical Services conducting approval tests and of the Type Approval Authorities which grant approval and to which forms certifying approval or refusal or withdrawal of approval, issued in other countries, are to be sent.

ANNEX 1

Appendix 1

COMMUNICATION

(Maximum format: A4 (210 × 297 mm))



issued by: Name of administration

- concerning ⁽²⁾: Approval granted
 Approval extended
 Approval refused
 Approval withdrawn
 Production definitively discontinued

of a vehicle type with regard ⁽²⁾: To the tank for liquid fuel
 To the prevention of fire risks in the event of frontal/lateral/rear ⁽²⁾ collision
 Pursuant to Regulation No 34.

Approval No Extension No

1. Trade name or mark of the power-driven vehicle:
2. Vehicle type:
3. Manufacturer's name and address:
4. If applicable, name and address of manufacturer's representative:
5. Kind of engine: positive-ignition/diesel ⁽²⁾
6. Site of engine: front/rear/centre ⁽²⁾
7. Brief description of fuel tank and fuel or approval number(s) of the approved fuel tank ⁽²⁾
- 7.1. Characteristics and site of fuel tank:
- 7.2. For fuel tanks made of a plastic material, state material and trade name or mark:
- 7.3. Characteristics of fuel installation (site, connections, etc.):
8. Description of electrical installation (site attachment, protection, etc.):
9. Description of the impact tests:
- Frontal (Type/Approval or report number):
- Side (Type/Approval or report number):
- Rear (Type/Approval or report number):
10. Vehicle submitted for approval on:
11. Technical Service responsible for conducting approval tests:
12. Date of report issued by that Service:
13. Number of report issued by that Service:

14. Approval granted/extended/refused/withdrawn ⁽²⁾
15. Position of approval mark on the vehicle:
16. Place:
17. Date:
18. Signature:
19. The following documents, bearing the approval number shown above, are annexed to this communication:
Drawings and layout diagrams of the fuel tank, the fuel installation, the electrical installation, and other components of importance for the purposes of this Regulation.

⁽¹⁾ Distinguishing number of the country which has granted/extended/refused/withdrawn/the approval (see approval provisions in the Regulation).

⁽²⁾ Strike out what does not apply.

Appendix 2

COMMUNICATION

(Maximum format: A4 (210 × 297 mm))

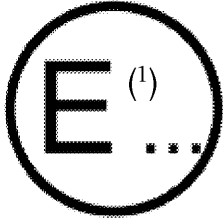

issued by: Name of administration

.....
.....
.....

- concerning ⁽²⁾: Approval granted
- Approval extended
- Approval refused
- Approval withdrawn
- Production definitively discontinued

of a fuel tank pursuant to Regulation No 34.

Approval No Extension No

1. Trade name or mark of the fuel tank:
2. Manufacturer's name for the type of fuel tank:
3. Manufacturer's name and address:
4. If applicable, name and address of manufacturer's representative:
5. Brief description of fuel tank and fuel of the fuel feeding installation:
- 5.1. Characteristics of fuel tank and fuel:
- 5.2. For fuel tanks made of a plastic material, state material and trade name or mark:
6. Submitted for approval on:
7. Technical Service responsible for conducting approval tests:
8. Date of report issued by that Service:
9. Number of report issued by that Service:
10. Reason(s) for extension (if applicable):
11. Approval granted/extended/refused/withdrawn ⁽²⁾
12. Position of approval mark on the fuel tank:
13. Place:
14. Date:
15. Signature:
16. The index to the information package lodged with the Type Approval Authority, which may be obtained on request, is attached.

⁽¹⁾ Distinguishing number of the country which has granted/extended/refused/withdrawn/the approval (see approval provisions in the Regulation).
⁽²⁾ Strike out what does not apply.

ANNEX 2

ARRANGEMENTS OF APPROVAL MARKS

MODEL A

(See paragraph 3.1.4 of this Regulation)

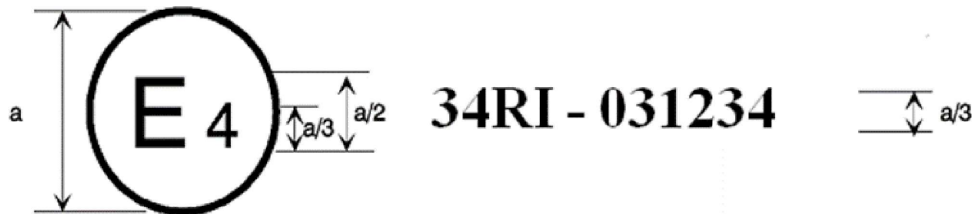

a = 8 mm minimum

The above approval mark affixed to a vehicle shows that the type concerned was approved in the Netherlands (E4) pursuant to Part I of Regulation No 34 under approval No 031234. The first two digits (03) of the approval number indicate that the approval was granted in accordance with the requirements of Regulation No 34 as amended by the 03 series of amendments.

MODEL B

(See paragraph 3.1.5 of this Regulation)

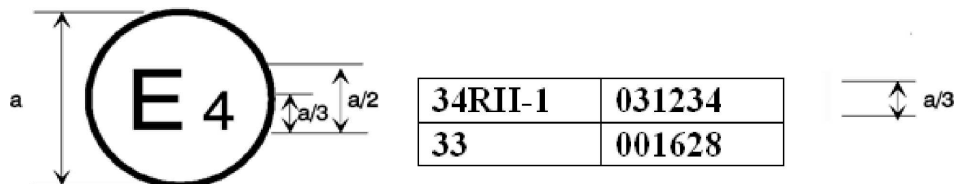

a = 8 mm minimum

The above approval mark affixed to a vehicle shows that the type concerned was approved in the Netherlands (E4) pursuant to Regulations Nos 34 Parts I or IV and II-1 and 33 (*). The approval numbers indicated that, at the date when the respective approvals were given, Regulation No 34 included the 03 series of amendments and Regulation No 33 was still in its original form.

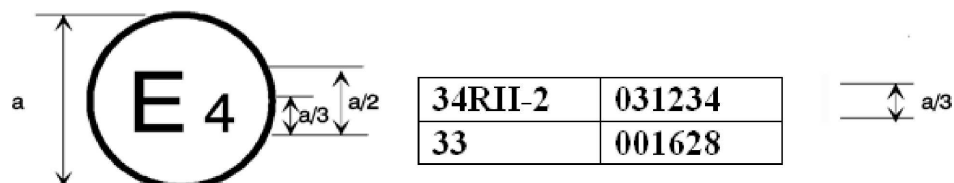

a = 8 mm minimum

The above approval mark affixed to a vehicle shows that the type concerned was approved in the Netherlands (E4) pursuant to Regulations Nos 34 Parts I or IV and II-2 and 33 (*). The approval numbers indicated that, at the date when the respective approvals were given, Regulation No 34 included the 03 series of amendments and Regulation No 33 was still in its original form.

(*) The second number is given merely as an example.

MODEL C

(See paragraph 3.2.4 of this Regulation)



a = 8 mm minimum

The above approval mark affixed to a fuel tank shows that the type concerned was approved in the Netherlands (E4) pursuant to Part III of Regulation No 34, for a universal use including its accessories, under approval No 031234. The first two digits (03) of the approval number indicate that the approval was granted in accordance with the requirements of Regulation No 34 as amended by the 03 series of amendments.

MODEL D

(See paragraph 3.3.4 of this Regulation)

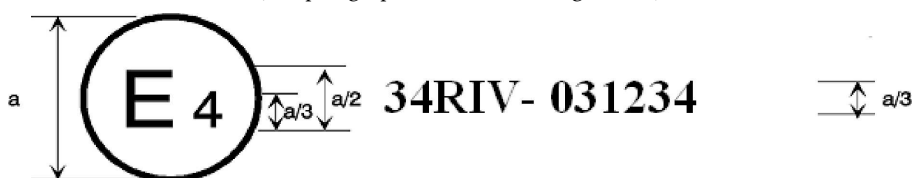

a = 8 mm minimum

The above approval mark affixed to a vehicle shows that the type concerned was approved in the Netherlands (E4) pursuant to Part IV of Regulation No 34 under approval No 031234. The first two digits (03) of the approval number indicate that the approval was granted in accordance with the requirements of Regulation No 34 as amended by the 03 series of amendments.

MODEL E

(See paragraph 3.3.5 of this Regulation)

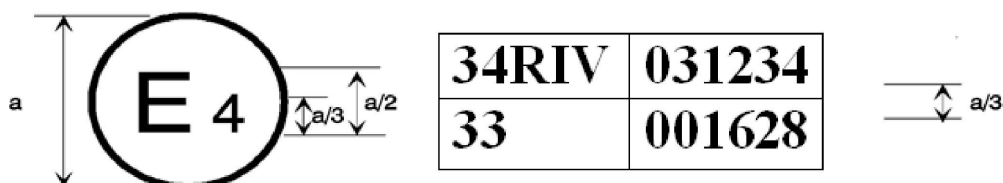

a = 8 mm minimum

The above approval mark affixed to a vehicle shows that the type concerned was approved in the Netherlands (E4) pursuant to Regulations Nos 34 Part IV and 33 (*). The approval numbers indicated that, at the date when the respective approvals were given, Regulation No 34 included the 03 series of amendments and Regulation No 33 was still in its original form.

(*) The second number is given merely as an example.

ANNEX 3

FRONTAL COLLISION TEST AGAINST A BARRIER

1. PURPOSE AND SCOPE

The purpose of this test is to simulate the conditions of frontal collision against a fixed obstacle or by another vehicle approaching from the opposite direction.

2. INSTALLATIONS, PROCEDURES AND MEASURING INSTRUMENTS

2.1. Testing ground

The test area shall be large enough to accommodate the run-up track, barrier and technical installations necessary for the test. The last part of the track, for at least 5 m before the barrier, shall be horizontal, flat and smooth.

2.2. Barrier

The barrier consists of a block of reinforced concrete not less than 3 m wide in front and not less than 1,5 m high. The barrier shall be of such thickness that it weighs at least 70 tonnes. The front face shall be vertical, perpendicular to the axis of the run-up track, and covered with plywood boards 2 cm thick in good condition. The barrier shall be either anchored in the ground or placed on the ground with, if necessary, additional arresting devices to limit its displacement. A barrier with different characteristics, but giving results at least equally conclusive, may likewise be used.

2.3. Propulsion of vehicle

At the moment of collision, the vehicle shall no longer be subject to the action of any additional steering or propelling device. It shall reach the obstacle on a course perpendicular to the collision wall; the maximum lateral misalignment tolerated between the vertical median line of the front of the vehicle and the vertical median line of the collision wall is ± 30 cm.

2.4. State of vehicle

2.4.1. The vehicle under test shall either be fitted with all the normal components and equipment included in its unladen kerb weight or be in such condition as to fulfil this requirement so far as the components and equipment affecting fire risks are concerned.

2.4.2. If the vehicle is driven by external means, the fuel installation shall be filled to at least 90 per cent of its capacity either with fuel or with a non-inflammable liquid having a density and a viscosity close to those of the fuel normally used. All other systems (brake-fluid header tanks, radiator, etc.) may be empty.

2.4.3. If the vehicle is driven by its own engine, the fuel tank shall be at least 90 per cent full. All other liquid-holding tanks may be filled to capacity.

2.4.4. If the manufacturer so requests, the technical service responsible for conducting the tests may allow the same vehicle as is used for tests prescribed by other Regulations (including tests capable of affecting its structure) to be used also for the tests prescribed by this Regulation.

2.5. Velocity on collision

The velocity on collision shall be between 48,3 km/h and 53,1 km/h. However, if the test has been carried out at a higher collision velocity and the vehicle has satisfied the conditions prescribed, the test shall be considered satisfactory.

2.6. Measuring instruments

The instrument used to record the speed referred to in paragraph 2.5 above shall be accurate to within one per cent.

3. EQUIVALENT TEST METHODS

- 3.1. Equivalent test methods are permitted provided that the conditions referred to in this Regulation can be observed either entirely by means of the substitute test or by calculation from the results of the substitute test.
 - 3.2. If a method other than that described in paragraph 2 above is used its equivalence shall be demonstrated.
-

ANNEX 4

PROCEDURE FOR REAR-END COLLISION TEST

1. PURPOSE AND SCOPE

1.1. The purpose of the test is to simulate the conditions of rear-end collision by another vehicle in motion.

2. INSTALLATIONS, PROCEDURES AND MEASURES INSTRUMENTS

2.1. Testing ground

The test area shall be large enough to accommodate the impactor (striker) propulsion system and to permit after-collision displacement of the vehicle struck and installation of the test equipment. The part in which vehicle collision and displacement occur shall be horizontal, flat and uncontaminated, and representative of a normal, dry, uncontaminated road surface.

2.2. Impactor (striker)

2.2.1. The impactor shall be of steel and of rigid construction.

2.2.2. The impacting surface shall be flat, not less than 2 500 mm wide, and 800 mm high, and its edges shall be rounded to a radius of curvature of between 40 and 50 mm. It shall be clad with a layer of plywood 20 +/- 2 mm thick, in good condition.

2.2.3. At the moment of collision the following requirements shall be met:

2.2.3.1. The impacting surface shall be vertical and perpendicular to the median longitudinal plane of the vehicle struck;

2.2.3.2. The direction of movement of the impactor shall be substantially horizontal and parallel to the median longitudinal plane of the vehicle struck;

2.2.3.3. The maximum lateral deviation tolerated between the median vertical line of the surface of the impactor and the median longitudinal plane of the vehicle struck shall be 300 mm. In addition, the impacting surface shall extend over the entire width of the vehicle struck;

2.2.3.4. The ground clearance of the lower edge of the impacting surface shall be 175 ± 25 mm.

2.3. Propulsion of the impactor

The impactor may either be secured to a carriage (moving barrier) or form part of a pendulum.

2.4. Special provisions applicable where a moving barrier is used

2.4.1. If the impactor is secured to a carriage (moving barrier) by a restraining element, the latter shall be rigid and be incapable of being deformed by the collision; the carriage shall at the moment of collision be capable of moving freely and no longer be subject to the action of the propelling device.

2.4.2. The velocity of collision shall be between 48 km/h and 52 km/h.

2.4.3. The aggregate weight (mass) of carriage and impactor shall be $1\ 100 \pm 20$ kg.

2.5. Special provisions applicable where a pendulum is used

2.5.1. The distance between the centre of the impacting face and the axis of rotation of the pendulum shall be not less than 5 m.

2.5.2. The impactor shall be freely suspended by rigid arms rigidly secured to it. The pendulum so constituted shall be substantially incapable of being deformed by the collision.

- 2.5.3. Arresting gear shall be incorporated in the pendulum to prevent any secondary collision by the impactor on the test vehicle.
- 2.5.4. At the moment of collision the velocity of the centre of percussion of the pendulum shall be between 48 and 52 km/h.
- 2.5.5. The reduced mass 'm_r' at the centre of percussion of the pendulum is defined as a function of the total mass 'm', of the distance 'a' (1) between the centre of percussion and the axis of rotation, and of the distance 'l' between the centre of gravity and the axis of rotation, by the following equation:

$$m_r = m (l/a)$$

- 2.5.6. The reduced mass m_r shall be 1 100 ± 20 kg.
- 2.6. General provisions relating to the mass and velocity of the impactor
- If the test has been conducted at a collision velocity higher than those prescribed in paragraphs 2.4.2 and 2.5.4 and/or with a mass greater than those prescribed in paragraphs 2.4.3 and 2.5.6, and the vehicle has met the requirements prescribed, the test shall be considered satisfactory.
- 2.7. State of vehicle under test
- 2.7.1. The vehicle under test shall either be fitted with all the normal components and equipment included in its unladen kerb weight or be in such condition as to fulfil this requirement so far as the components and equipment affecting fire risks are concerned.
- 2.7.2. The fuel tank shall be filled to at least 90 per cent of its capacity either with fuel or with a non-inflammable liquid having a density and a viscosity close to those of the fuel normally used. All other systems (brake-fluid header tanks, radiator, etc.) may be empty.
- 2.7.3. A gear may be engaged and the brakes may be applied.
- 2.7.4. If the manufacturer so requests, the following derogation shall be permitted:
- 2.7.4.1. the technical service responsible for conducting the tests may allow the same vehicle as is used for tests prescribed by other Regulations (including tests capable of affecting its structure) to be used also for the tests prescribed by this Regulation; and
- 2.7.4.2. The vehicle may be weighted to an extent not exceeding 10 per cent of its unladen kerb weight with additional weights rigidly secured to the structure in such a way as not to affect the behaviour of the structure of the passenger compartment during the test.
- 2.8. Measuring instruments
- The instruments used to record the speed referred to in paragraphs 2.4.2 and 2.5.4 above shall be accurate to within one per cent.
3. EQUIVALENT TEST METHODS
- 3.1. Equivalent test methods are permitted provided that the conditions referred to in this Regulation can be observed either entirely by means of the substitute test or by calculation from the results of the substitute test.
- 3.2. If a method other than that described in paragraph 2 above is used, its equivalence shall be demonstrated.

(1) It is recalled that the distance 'a' is equal to the length of the synchronous pendulum under consideration.

ANNEX 5

TESTING OF FUEL TANKS MADE OF A PLASTIC MATERIAL

1. COLLISION RESISTANCE

- 1.1. The tank shall be filled to its capacity with a water-glycol mixture or with another liquid having a low freezing point, which does not change the properties of the tank material, and shall then be subjected to a perforation test.
- 1.2. During this test the tank temperature shall be $233 \text{ K} \pm 2 \text{ K}$ ($-40 \text{ }^\circ\text{C} \pm 2 \text{ }^\circ\text{C}$).
- 1.3. A pendulum collision testing fixture shall be used for the test. The collision body shall be of steel and have the shape of a pyramid with equilateral-triangle faces and a square base, the summit and the edges being rounded to a radius of 3 mm. The centre of percussion of the pendulum shall coincide with the centre of gravity of the pyramid; its distance from the axis of rotation of the pendulum shall be 1 m. The total mass of the pendulum shall be 15 kg. The energy of the pendulum at the moment of collision shall be not less than 30 Nm and as close to that value as possible.
- 1.4. The tests shall be made on the points of the tank which are regarded as vulnerable to frontal or rear collisions. The points regarded as vulnerable are those which are most exposed or weakest having regard to the shape of the tank or the way in which it is installed on the vehicle. The points selected by the laboratories shall be indicated in the test report.
- 1.5. During the test, the tank shall be held in position by the fittings on the side or sides opposite the side of collision. No leak shall result from the test.
- 1.6. At the choice of the manufacturer, all the impact tests may be carried out on one tank or each may be carried out on a different tank.

2. MECHANICAL STRENGTH

The tank shall be tested under the conditions prescribed in paragraph 6.1 of this Regulation for leaks and for rigidity of shape. The tank and all its accessories shall be mounted onto a test fixture in a manner corresponding to the mode of installation on the vehicle for which the tank is intended or mounted in the vehicle itself or mounted in a test fixture made by a vehicle section. On request of the manufacturer and with the agreement of the Technical Service the tank may be tested without using any test fixture. Water at 326 K ($53 \text{ }^\circ\text{C}$) shall be used as the testing fluid and shall fill the tank to its capacity. The tank shall be subjected to a relative internal pressure equal to double the working pressure and in any case to not less than 30 kPa at a temperature of $326 \text{ K} \pm 2 \text{ K}$ ($53 \text{ }^\circ\text{C} \pm 2 \text{ }^\circ\text{C}$) for a period of five hours. During the test, the tank and its accessories shall not crack or leak; however, it may be permanently deformed.

3. FUEL PERMEABILITY

- 3.1. The fuel used for the permeability test shall be either the reference fuel specified in Regulation No 83, Annex 9 or a commercial premium-grade fuel. If the tank is only designed for installation on vehicles with a compression-ignition engine, the tank shall be filled with diesel fuel.
- 3.2. Prior to the test, the tank shall be filled to 50 per cent of its capacity with testing fuel and stored, without being sealed, at an ambient temperature of $313 \text{ K} \pm 2 \text{ K}$ ($40 \text{ }^\circ\text{C} \pm 2 \text{ }^\circ\text{C}$) until the weight loss per unit time becomes constant, but for not more than four weeks (preliminary storage time).
- 3.3. The tank shall then be emptied and refilled to 50 per cent of its capacity with test fuel, after which it shall be hermetically sealed and be stored at a temperature of $313 \text{ K} \pm 2 \text{ K}$ ($40 \text{ }^\circ\text{C} \pm 2 \text{ }^\circ\text{C}$). The pressure shall be adjusted when the contents of the tank have reached the testing temperature. During the ensuing test period of eight weeks, the loss of weight due to diffusion during the test period shall be determined. The maximum permissible average loss of fuel is 20 g per 24 hours of testing time.

- 3.4. If the loss due to diffusion exceeds the value indicated in paragraph 3.3, the test described there shall be carried out again, on the same tank, to determine the loss by diffusion at $296\text{ K} \pm 2\text{ K}$ ($23\text{ °C} \pm 2\text{ °C}$) but under the same conditions otherwise. The loss so measured shall not exceed 10 g per 24 hours.

4. RESISTANCE TO FUEL

After the test referred to in paragraph 3, the tank shall still meet the requirements set out in paragraphs 1 and 2.

5. RESISTANCE TO FIRE

The tank shall be subjected to the following tests.

- 5.1. For two minutes, the tank, fixed as on the vehicle, shall be exposed to flame. There shall be no leakage of liquid fuel from the tank.
- 5.2. Three tests shall be made on different tanks filled with fuel as follows:
- 5.2.1. If the tank is designed for installation on vehicles equipped with either a positive ignition engine or a compression ignition engine, three tests shall be carried out with tanks filled with premium-grade gasoline;
- 5.2.2. If the tank is only designed for installation on vehicles equipped with a compression-ignition engine, three tests shall be carried out with tanks filled with diesel fuel;
- 5.2.3. For each test, the tank and its accessories shall be installed in a testing fixture simulating actual mounting conditions as far as possible. The method whereby the tank is fixed in the fixture shall correspond to the relevant specifications for its installation. In the case of tanks designed for a specific vehicle use, vehicle parts which protect the tank and its accessories against exposure to flame or which affect the course of the fire in any way, as well as specified components installed on the tank and plugs shall be taken into consideration. All openings shall be closed during the test, but venting systems shall remain operative. Immediately prior to the test the tank shall be filled with the specified fuel to 50 per cent of its capacity.
- 5.3. The flame to which the tank is exposed shall be obtained by burning commercial fuel for positive-ignition engines (hereafter called 'fuel') in a pan. The quantity of fuel poured into the pan shall be sufficient to permit the flame, under free-burning conditions, to burn for the whole test procedure.
- 5.4. The pan dimensions shall be chosen so as to ensure that the sides of the fuel tank are exposed to the flame. The pan shall therefore exceed the horizontal projection of the tank by at least 20 cm, but not more than 50 cm. The sidewalls of the pan shall not project more than 8 cm above the level of the fuel at the start of the test.
- 5.5. The pan filled with fuel shall be placed under the tank in such a way that the distance between the level of the fuel in the pan and the tank bottom corresponds to the design height of the tank above the road surface at the unladen mass (see paragraph 7.4). Either the pan, or the testing fixture, or both, shall be freely movable.
- 5.6. During phase C of the test, the pan shall be covered by a screen placed $3\text{ cm} \pm 1\text{ cm}$ above the fuel level.

The screen shall be made of a refractory material, as prescribed in Appendix 2. There shall be no gap between the bricks and they shall be supported over the fuel pan in such a manner that the holes in the bricks are not obstructed. The length and width of the frame shall be 2 cm to 4 cm smaller than the interior dimensions of the pan so that a gap of 1 cm to 2 cm exists between the frame and the wall of the pan to allow ventilation.

- 5.7. When the tests are carried out in the open air, sufficient wind protection shall be provided and the wind velocity at fuel-pan level shall not exceed 2,5 km/h. Before the test the screen shall be heated to $308\text{ K} \pm 5\text{ K}$ ($35\text{ °C} \pm 5\text{ °C}$). The firebricks may be wetted in order to guarantee the same test conditions for each successive test.

5.8. The test shall comprise four phases (see Appendix 1).

5.8.1. Phase A: Pre-heating (Figure 1)

The fuel in the pan shall be ignited at a distance of at least 3 m from the tank being tested. After 60 seconds pre-heating, the pan shall be placed under the tank.

5.8.2. Phase B: Direct exposure to flame (Figure 2)

For 60 seconds the tank shall be exposed to the flame from the freely burning fuel.

5.8.3. Phase C: Indirect exposure to flame (Figure 3)

As soon as phase B has been completed, the screen shall be placed between the burning pan and the tank. The tank shall be exposed to this reduced flame for a further 60 seconds.

5.8.4. Phase D: End of test (Figure 4)

The burning pan covered with the screen shall be moved back to its original position (phase A). If, at the end of the test, the tank is burning, the fire shall be extinguished forthwith.

5.9. The results of the test shall be considered satisfactory if no liquid fuel is leaking from the tank.

6. RESISTANCE TO HIGH TEMPERATURE

6.1. The fixture used for the test shall match the manner of installation of the tank on the vehicle, including the way in which the tank vent works.

6.2. The tank filled to 50 per cent of its capacity with water at 293 K (20 °C) shall be subjected for one hour to an ambient temperature of 368 K \pm 2 K (95 °C \pm 2 °C).

6.3. The results of the test shall be considered satisfactory if, after the test, the tank is not leaking or seriously deformed.

7. MARKINGS ON THE FUEL TANK

The trade name or mark shall be affixed to the tank; it shall be indelible and clearly legible on the tank when the latter is installed on the vehicle.

Appendix 1

TEST OF RESISTANCE TO FIRE

Figure 1

Phase A: Pre-heating

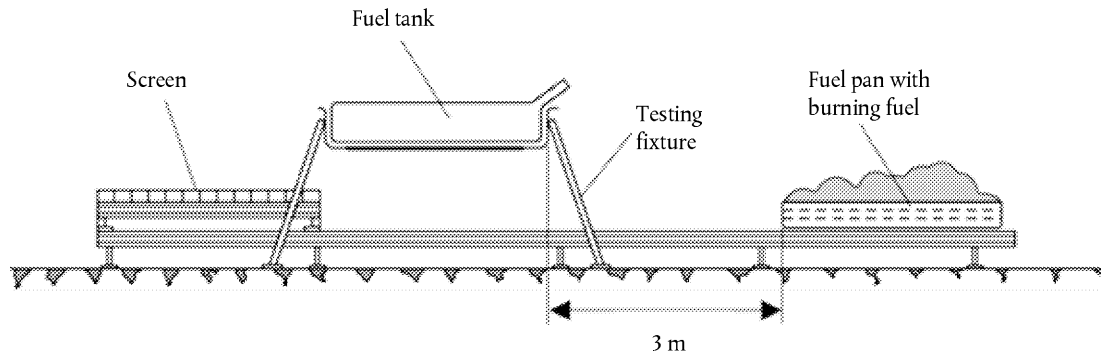

Figure 2

Phase B: Direct exposure to flame

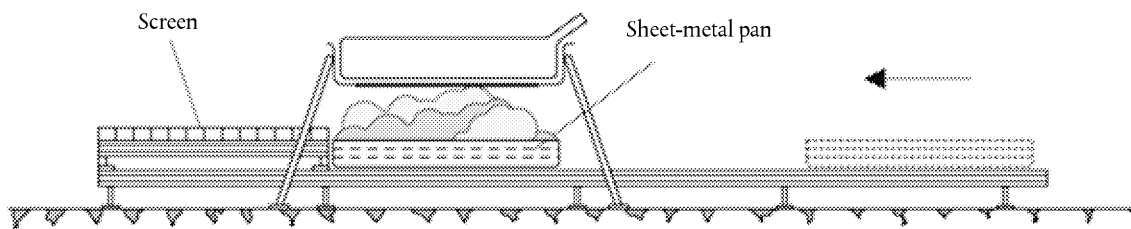

Figure 3

Phase C: Indirect exposure to the flame

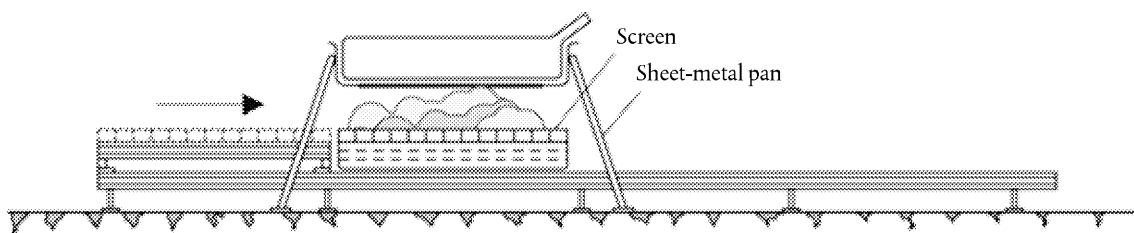
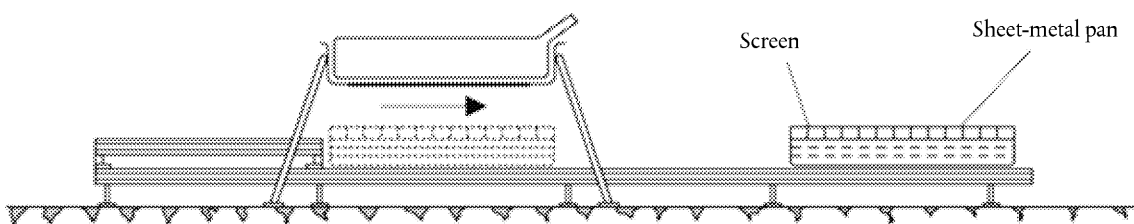

Figure 4

Phase D: End of test



Appendix 2

DIMENSIONS AND TECHNICAL DATA OF FIREBRICKS

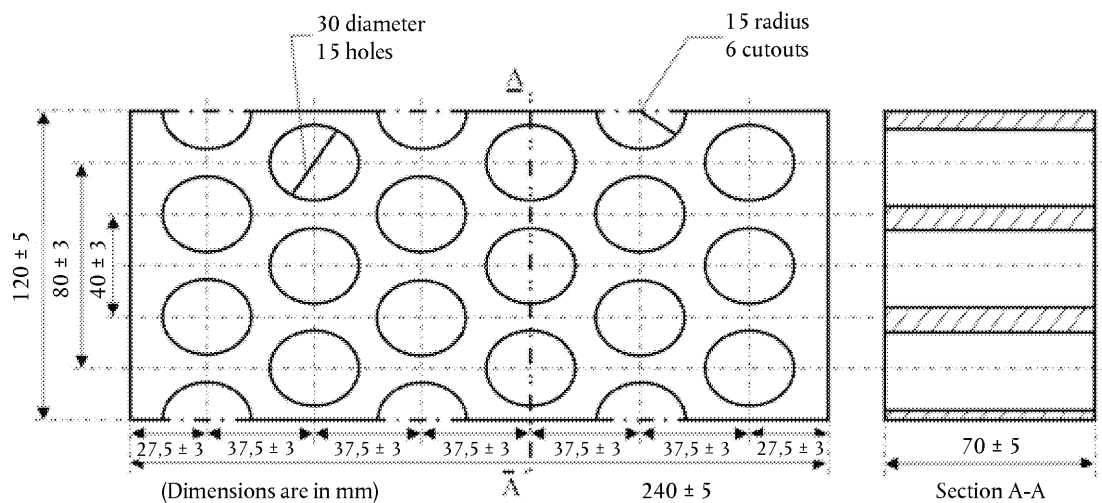

Fire resistance (Seger-Kegel)	SK 30
Al ₂ O ₃ content	30-33 per cent
Open porosity (P _o)	20-22 per cent vol.
Density	1 900-2 000 kg/m ³
Effective holed area	44,18 per cent