

COMMISSION DIRECTIVE 1999/17/EC

of 18 March 1999

adapting to technical progress Council Directive 76/761/EEC relating to motor vehicle headlamps which function as main-beam and/or dipped-beam headlamps and to incandescent electric filament lamps for such headlamps

(Text with EEA relevance)

THE COMMISSION OF THE EUROPEAN COMMUNITIES,

Having regard to the Treaty establishing the European Community,

Having regard to Council Directive 70/156/EEC of 6 February 1970 on the approximation of the laws of the Member States relating to the type-approval of motor vehicles and their trailers⁽¹⁾, as last amended by Directive 98/91/EC of the European Parliament and of the Council⁽²⁾, and in particular Article 13(2) thereof,

Having regard to Council Directive 76/761/EEC of 27 July 1976 on the approximation of the laws of the Member States relating to motor vehicle headlamps which function as main-beam and/or dipped-beam headlamps and to incandescent electric filament lamps for such headlamps⁽³⁾, as last amended by the Act of Accession of Austria, Finland and Sweden, and in particular Article 10 thereof,

(1) Whereas Directive 76/761/EEC is one of the separate Directives of the EC type-approval procedure which has been established by Directive 70/156/EEC; whereas, consequently, the provisions laid down in Directive 70/156/EEC relating to vehicle systems, components and separate technical units apply to Directive 76/761/EEC;

(2) Whereas, in particular, Article 3(4) and Article 4(3) of Directive 70/156/EEC require each separate Directive to have attached to it an information document and also a type-approval certificate based on Annex VI to Directive 70/156/EEC in order that type-approval may be computerised; whereas the type-approval certificate(s) provided for in Directive 76/761/EEC should be amended accordingly;

(3) Whereas the procedures should be simplified in order to maintain the equivalence envisaged by Article 9(2) of Directive 70/156/EEC between certain separate Directives and the corresponding regulations of the United Nations' Economic Commission for Europe (UN-ECE) when those regulations are amended; whereas, as a first step, the technical requirements of Directive 76/761/EEC should be replaced by those of UN-ECE Regulations Nos 1, 5, 8, 20, 31, 37, 98 and 99 by way of cross-reference;

(4) Whereas it is necessary to ensure that the requirements in Council Directive 76/756/EEC⁽⁴⁾, as last amended by Commission Directive 97/28/EC⁽⁵⁾, are complied with;

(5) Whereas the measures provided for in this Directive are in accordance with the opinion of the Committee for adaptation to technical progress established by Directive 70/156/EEC,

HAS ADOPTED THIS DIRECTIVE:

Article 1

Directive 76/761/EEC is amended as follows:

1. The title is replaced by the following:

'on the approximation of the laws of the Member States relating to motor vehicle headlamps which function as main-beam and/or dipped-beam headlamps and to light sources (filament lamps and others) for use in approved lamp units of motor vehicles and of their trailers.'

⁽¹⁾ OJ L 42, 23.2.1970, p. 1.

⁽²⁾ OJ L 11, 16.1.1999, p. 25.

⁽³⁾ OJ L 262, 27.9.1976, p. 96.

⁽⁴⁾ OJ L 262, 27.9.1976, p. 1.

⁽⁵⁾ OJ L 171, 30.6.1997, p. 1.

2. In Article 1, paragraph 1 is replaced by the following:

‘1. Each Member State shall grant EC component type-approval for any type of headlamp which functions as a main-beam and/or dipped-beam headlamp and for any type of light source (filament lamp(s) and other(s)) for use in approved lamp units which satisfy the construction and testing requirements laid down in the relevant Annexes.’

3. Articles 2, 3 and 4 are replaced by the following:

‘Article 2

Member States shall, for each type of headlamp which functions as a main-beam and/or dipped-beam headlamp or for each type of light source (filament lamp(s) and other(s)) for use in approved lamp units which they approve pursuant to Article 1, issue to the manufacturer an EC component type-approval mark conforming to the model shown in Annex I, Appendix 5.

Member States shall take all appropriate measures to prevent the use of marks liable to create confusion between headlamps which function as main-beam and/or dipped-beam headlamps and light source(s) (filament lamp(s) and other(s)) for use in approved lamp units which have been type-approved pursuant to Article 1, and other devices.

Article 3

1. No Member State may prohibit the placing on the market of headlamps which function as main-beam and/or dipped-beam headlamps and light source(s) (filament lamp(s) and other(s)) for use in approved lamp units on grounds relating to their construction or method of functioning, if they bear the EC component type-approval mark.

2. A Member State may prohibit the placing on the market of headlamps which function as main-beam and/or dipped-beam headlamps and light source(s) (filament lamp(s) and other(s)) for use in approved lamp units bearing the EC component type-approval mark which consistently fail to conform to the approved type.

That State shall forthwith inform the other Member States and the Commission of the measures taken, specifying the reasons for its decision.

Article 4

The competent authorities of the Member States shall inform each other, by means of the procedure

specified in Article 4(6) of Directive 70/156/EEC, of each approval which they have granted, refused or withdrawn pursuant to this Directive.’

4. In Article 5(1), the first sentence is replaced by the following:

‘If the Member State which has granted EC component type-approval finds that a number of headlamps which function as main-beam and/or dipped-beam headlamps or light source(s) (filament lamp(s) and other(s)) for use in approved lamp units bearing the same EC component type-approval mark do not conform to the type which it has approved, it shall take the necessary measures to ensure that production models conform to the approved type.’

5. In Article 6, the first sentence is replaced by the following:

‘Any decision taken pursuant to the provisions adopted in implementation of this Directive to refuse or withdraw EC component type-approval for a main-beam or a dipped-beam headlamp or for a light source(s) (filament lamp(s) and other(s)) for use in approved lamp units or prohibit their placing on the market or use shall set out in detail the reasons on which it is based.’

6. Articles 7, 8 and 9 are replaced by the following:

‘Article 7

No Member State may refuse to grant EC type-approval or national type-approval of a vehicle on grounds relating to its headlamps which function as main-beam and/or dipped-beam headlamps or to the light source(s) (filament lamp(s) and other(s)) for use in approved lamp units if these bear the EC component type-approval mark and are fitted in accordance with the requirements laid down in Directive 76/756/EEC.

Article 8

No Member State may refuse or prohibit the sale or registration, entry into service or use of a vehicle on grounds relating to its headlamps which function as main-beam and/or dipped-beam headlamps or to the light source(s) (filament lamp(s) and other(s)) for use in approved lamp units if these bear the EC component type-approval mark and are fitted in accordance with the requirements laid down in Directive 76/756/EEC.

Article 9

For the purposes of this Directive, "vehicle" means any motor vehicle intended for use on the road, with or without bodywork, having at least four wheels and a maximum design speed exceeding 25 km/h, with the exception of vehicles which run on rails and of agricultural and forestry tractors and all mobile machinery.'

7. The Annexes are replaced by the text in the Annex to this Directive.

Article 2

1. From 1 October 1999, or, if the publication of the texts referred to in Article 3 is delayed beyond 1 April 1999, six months after the actual date of publication of these texts, Member States may not, on grounds relating to headlamps which function as main-beam and/or dipped-beam headlamps and to light sources (filament lamps and others) for use in approved lamp units, hereinafter referred to as 'headlamps' and 'light sources', respectively:

- refuse, in respect of a type of vehicle or a type of headlamp or light source, to grant EC type-approval or national type-approval, or
- prohibit the registration, sale or entry into service of vehicles, or the sale or entry into service of headlamps or light sources,

provided that the headlamps or light sources comply with the requirements of Directive 76/761/EEC, as amended by this Directive, and that, as far as vehicles are concerned, they are installed in accordance with the requirements laid down in Directive 76/756/EEC.

2. From 1 April 2000 Member States:

- shall no longer grant EC type-approval, and
- may refuse to grant national type-approval

for any type of vehicle on grounds relating to headlamps or light sources, and for any type of headlamp or light source, if the requirements of Directive 76/761/EEC, as amended by this Directive, are not fulfilled.

3. From 1 April 2001 the requirements of Directive 76/761/EEC relating to headlamps or light sources as

components, as amended by this Directive, shall be applicable for the purposes of Article 7(2) of Directive 70/156/EEC.

4. Notwithstanding paragraphs 2 and 3, for the purposes of replacement parts Member States shall continue to grant EC type-approval of headlamps and light sources and to permit their sale and entry into service in accordance with previous versions of Directive 76/761/EEC provided that such headlamps and light sources

- are intended to be fitted to vehicles already in use, and
- comply with the requirements of that Directive which were applicable when the vehicles were first registered.

Article 3

The paragraphs and annexes of UN-ECE Regulations Nos 1, 5, 8, 20, 31, 37, 98 and 99, referred to in Annexes II, III, IV, V, VI, VII, VIII and IX, items 2.1, shall be published in the *Official Journal of the European Communities* before 1 April 1999.

Article 4

1. Member States shall bring into force the laws, regulations and administrative provisions necessary to comply with this Directive by 1 October 1999; however, if the publication of the texts referred to in Article 3 is delayed beyond 1 April 1999, the Member States shall comply with this obligation six months after the actual date of publication of these texts. They shall forthwith inform the Commission thereof.

They shall apply those provisions from 1 October 1999, or, if the publication of the texts referred to in Article 3 is delayed beyond 1 April 1999, six months after the actual date of publication of those texts.

When Member States adopt those provisions, they shall contain a reference to this Directive or shall be accompanied by such a reference on the occasion of their official publication. Member States shall determine how such reference is to be made.

2. Member States shall communicate to the Commission the texts of the main provisions of national law which they adopt in the field covered by this Directive.

Article 6

This Directive is addressed to the Member States.

Article 5

Done at Brussels, 18 March 1999.

This Directive shall enter into force on the twentieth day following that of its publication in the *Official Journal of the European Communities*.

For the Commission
Martin BANGEMANN
Member of the Commission

ANNEX

‘LIST OF ANNEXES

- ANNEX I: Administrative provisions for type approval
Appendix 1: Information document (headlamps)
Appendix 2: Information document (light sources)
Appendix 3: Type-approval certificate (headlamps)
Appendix 4: Type-approval certificate (light sources)
Appendix 5: Models of the EC component type-approval mark
- ANNEX II: Scope and technical requirements for headlamps equipped with filament lamps of categories R2 and/or HS1
- ANNEX III: Scope and technical requirements for sealed-beam headlamps
- ANNEX IV: Scope and technical requirements for headlamps equipped with halogen filament lamps of categories H₁, H₂, H₃, HB₃, HB₄, H₇ and/or H₈
- ANNEX V: Scope and technical requirements for headlamps equipped with halogen filament lamps of category H₄
- ANNEX VI: Scope and technical requirements for halogen sealed-beam headlamps
- ANNEX VII: Scope and technical requirements for filament lamps for use in approved lamp units
- ANNEX VIII: Scope and technical requirements for headlamps equipped with gas-discharge light sources
- ANNEX IX: Gas-discharge light sources for use in approved gas-discharge lamp units

Note: As used in the Annexes the term “driving beam” is synonymous with “main beam”, and the term “passing beam” is synonymous with “dipped beam”.

ANNEX I

ADMINISTRATIVE PROVISIONS FOR TYPE APPROVAL

1. This Annex deals with the component type-approval of
 - 1.1. motor vehicle headlamps emitting an asymmetrical passing beam or a driving beam or both, equipped with filament lamps of categories R2 and/or HS1 and complying with the requirements set out in Annex II;
 - 1.2. motor vehicle "sealed-beam" headlamps emitting an asymmetrical passing beam or a driving beam or both and complying with the requirements set out in Annex III;
 - 1.3. motor vehicle headlamps emitting an asymmetrical passing beam or a driving beam or both, equipped with halogen filament lamps of categories H₁, H₂, H₃, HB₃, HB₄, H₇ and/or H₈ and complying with the requirements set out in Annex IV;
 - 1.4. motor vehicle headlamps emitting an asymmetrical passing beam or a driving beam or both, equipped with halogen filament lamps of category H₄ and complying with the requirements set out in Annex V;
 - 1.5. halogen "sealed-beam" motor vehicle headlamps emitting an asymmetrical passing beam or a driving beam or both and complying with the requirements set out in Annex VI;
 - 1.6. filament lamps for use in approved lamp units of motor vehicles and of their trailers complying with the requirements set out in Annex VII;
 - 1.7. motor vehicle headlamps equipped with gas-discharge light sources and complying with the requirements set out in Annex VIII;
 - 1.8. gas-discharge light sources for use in approved gas-discharge lamp units of motor vehicles complying with the requirements set out in Annex IX.
2. APPLICATION FOR EC COMPONENT TYPE-APPROVAL
 - 2.1. The application for EC component type-approval pursuant to Article 3(4) of Directive 70/156/EEC of a type of headlamp shall be submitted by the manufacturer.
 - 2.1.1. A model for the information document is given in Appendix 1.
 - 2.1.2. The following must be submitted to the technical service responsible for conducting the type-approval tests:
 - 2.1.2.1. Samples as follows:
 - 2.1.2.1.1. of a type of headlamp referred to in points 1.1., 1.3. and 1.4. above: two samples;
 - 2.1.2.1.2. of a type of headlamp referred to in points 1.2. and 1.5. above: five samples;
 - 2.1.2.1.3. of a type of headlamp referred to in point 1.7. above: two samples with standard gas-discharge light source and one ballast of each type to be used, where applicable;

- 2.1.2.2. for the test of plastic material of which the lenses are made:
- 2.1.2.2.1. thirteen lenses (fourteen lenses in the case of headlamps referred to in point 1.7.);
 - 2.1.2.2.2. six (ten) of these lenses may be replaced by six (ten) samples of material, at least 60 mm × 80 mm in size, having a flat or convex outer surface and a substantially flat area (radius of curvature not less than 300 mm) in the middle measuring at least 15 mm × 15 mm;
 - 2.1.2.2.3. every such lens or sample of material shall be produced by the method to be used in mass production;
 - 2.1.2.2.4. a reflector to which the lenses can be fitted in accordance with the manufacturer's instructions.
- 2.1.2.3. For testing, where applicable, the UV-resistance of light transmitting components made of plastic material against UV radiation of gas-discharge light sources inside the headlamp:
- 2.1.2.3.1. One sample each of the relevant material as being used in the headlamp or one headlamp sample containing these. Each material sample shall have the same appearance and surface treatment — if any — as intended for use in the headlamp to be approved.
 - 2.1.2.3.2. The UV-resistance testing of internal materials to light source radiation is not necessary if low-UV-type gas-discharge light sources are being applied, or if provisions are taken to shield the relevant components from UV radiation, e.g. by glass filters.
 - 2.1.2.4. The materials making up the lenses and coatings, if any, shall be accompanied by the report of the characteristics of these materials and coatings if they have already been tested.
- 2.2. The application for EC component type-approval pursuant to Article 3(4) of Directive 70/156/EEC of a type of light source shall be submitted by the manufacturer.
- 2.2.1. A model for the information document is given in Appendix 2.
 - 2.2.2. The following must be submitted to the technical service responsible for conducting the type-approval tests:
 - 2.2.2.1. of a type of filament lamp referred to in point 1.6. above: five samples of each colour which has been applied for;
 - 2.2.2.2. of a type of gas-discharge light source referred to in point 1.8. above: three samples and one sample of the ballast;
 - 2.2.2.3. in the case of a type of light source differing only by the trade name or mark from a type that has already been approved, it shall be sufficient to submit:
 - 2.2.2.3.1. a declaration by the manufacturer that the type submitted is (except in the trade name or mark) identical to, and has been produced by the same manufacturer as, the type already approved, the latter being identified by its approval code;
 - 2.2.2.3.2. two samples bearing the new trade name or mark.

3. MARKINGS
- 3.1. The devices submitted for EC component type approval must bear:
- 3.1.1. In the case of headlamps (*):
- 3.1.1.1. on the lens, the trade name or mark of the manufacturer;
- 3.1.1.2. on the lens and on the main body (**), spaces of sufficient size for the approval mark referred to in point 5; these spaces shall be indicated on the drawings referred to in Appendix 1;
- 3.1.1.3. if designed to satisfy the requirements of both right-hand and left-hand traffic, markings indicating the two settings of the optical unit on the vehicle or of the light source on the reflector; these markings shall consist of the letters "R/D" for the position for right-hand traffic and the letters "L/G" for the position for left-hand traffic;
- 3.1.1.4. All beams of lamps referred to in point 1.7 may bear on their light-emitting surface a centre of reference as shown in Annex 6 of the documents mentioned in point 2.1. of Annex VIII.
- 3.1.2. In the case of filament lamps on the cap or bulb, in which latter case the luminous characteristics shall not be adversely affected:
- 3.1.2.1. the trade name or mark of the manufacturer; if the same approval code has been assigned for several trade names or marks, one or more of them will suffice to meet this requirement;
- 3.1.2.2. the rated voltage;
- 3.1.2.3. the international designation of the relevant category;
- 3.1.2.4. the rated wattage (in the sequence, principal filament/secondary filament for dual-filament lamps); this need not be indicated separately if it is part of the international designation of the relevant filament lamp category;
- 3.1.2.5. a space of sufficient size to accommodate the approval mark which shall be indicated on the drawings referred to in Appendix 2.
- 3.1.2.6. Other inscriptions than those covered by points 3.1.2.1. to 3.1.2.5. and 6. may be affixed, on the condition that they do not adversely affect the luminous characteristics.
- 3.1.3. In the case of gas-discharge light sources on the cap:
- 3.1.3.1. the trade name or mark of the manufacturer;
- 3.1.3.2. the international designation of the relevant category;
- 3.1.3.3. the rated wattage; this need not be indicated separately if it is part of the international designation of the relevant category;

(*) In the case of headlamps designed to meet the requirements of traffic moving on one side of the road only (either right or left) it is further recommended that the area which can be occulted to prevent discomfort to users in a country where traffic moves on the side of the road opposite to that of the country for which the headlamp was designed should be outlined indelibly on the front lens and explained in the maintenance book of the vehicles. This marking is not necessary, however where the area is clearly apparent from the design.

(**) If the lens cannot be separated from the main body of the headlamp, the provision of a marking area on the lens will suffice.

- 3.1.3.4. a space of sufficient size to accommodate the approval mark which shall be indicated on the drawings referred to in Appendix 2.
- 3.1.3.5. Other inscriptions than those covered by items 3.1.3.1. to 3.1.3.4. and 6. may be affixed on the cap.
- 3.1.3.6. The ballast used for the type approval of the light source shall be marked with type and trade mark identification and with the rated voltage and wattage, as indicated on the relevant lamp data sheet.

4. GRANTING OF EC COMPONENT TYPE-APPROVAL

- 4.1. If the relevant requirements are satisfied, EC type-approval pursuant to Article 4(3) and, if applicable, Article 4(4) of Directive 70/156/EEC shall be granted.

NB: Nothing in this Directive shall prevent a Member State from prohibiting the combination of a headlamp incorporating a lens of plastic material approved under this Directive with a mechanical headlamp-cleaning device (with wipers).

- 4.2. A model for the EC type-approval certificate is given in

- 4.2.1. Appendix 3 for applications referred to in point 2.1.;

- 4.2.2. Appendix 4 for applications referred to in point 2.2.

- 4.3. An approval number in accordance with Annex VII to Directive 70/156/EEC shall be assigned to each type of headlamp approved. The same Member State shall not assign the same number to another type of headlamp.

- 4.4. Where EC component type approval is requested for a type of lighting and light-signalling device comprising a headlamp and other lamps, a single EC component type-approval number may be assigned provided that the headlamp complies with the requirements of this Directive and that each of the other lamps forming part of the lighting and light-signalling device for which EC component type approval is requested complies with the separate Directive applying to it.

- 4.5. An approval code shall be assigned to each type of light source approved. It consists of an identification code comprising not more than two characters selected from the Arabic numerals and capital letters listed in footnote (***) , preceded by a one-digit sequence number assigned to the most recent major technical amendment to the relevant Annex of Directive 76/761/EEC on the date EC type approval was granted. In this Directive the sequence number is

- 2 for Annex VII,

- 0 for Annex IX.

The same Member State shall not assign the same code to another type of light source.

5. EC COMPONENT TYPE-APPROVAL MARK FOR HEADLAMPS

- 5.1. In addition to the markings referred to in item 3.1., every headlamp conforming to the type approved pursuant to this Directive shall bear an EC component type-approval mark.

(***) 0 1 2 3 4 5 6 7 8 9
A B C D E F G H J K L M N P R S T U V W X Y Z.

- 5.2. This mark shall consist of:
- 5.2.1. a rectangle surrounding the letter "e" followed by the distinguishing number or letters of the Member State which has granted type approval:
- | | | | |
|----|------------------------|-----|----------------|
| 1 | for Germany | 12 | for Austria |
| 2 | for France | 13 | for Luxembourg |
| 3 | for Italy | 17 | for Finland |
| 4 | for the Netherlands | 18 | for Denmark |
| 5 | for Sweden | 21 | for Portugal |
| 6 | for Belgium | 23 | for Greece |
| 9 | for Spain | IRL | for Ireland; |
| 11 | for the United Kingdom | | |
- 5.2.2. in the vicinity of the rectangle the "base approval number" contained in section 4 of the type-approval number referred to in Annex VII of Directive 70/156/EEC, preceded by the two figures indicating the sequence number assigned to the most recent major technical amendment to the relevant Annex of Directive 76/761/EEC on the date EC type-approval was granted. In this Directive the sequence number is
- 01 for Annex II,
 - 02 for Annex III,
 - 04 for Annex IV,
 - 02 for Annex V,
 - 02 for Annex VI,
 - 00 for Annex VIII.
- 5.2.3. additional symbols as follows:
- 5.2.3.1. on headlamps meeting left-hand traffic requirements only, a horizontal arrow, pointing to the right of an observer facing the headlamp, i.e. to the side of the road on which the traffic moves;
- 5.2.3.2. on headlamps designed to meet the requirements of both traffic systems by means of an appropriate adjustment of the setting of the optical unit or the filament lamp, a horizontal arrow with a head on each end, the heads pointing respectively to the left and to the right;
- 5.2.3.3. on headlamps meeting the requirements of this Directive in respect of the passing beam only, the letter "C";
- 5.2.3.4. on headlamps meeting the requirements of this Directive in respect of the driving beam only, the letter "R";
- 5.2.3.5. on headlamps meeting the requirements of this Directive in respect of both the passing beam and the driving beam, the letters "CR";
- 5.2.3.6. preceded by the letter(s):
- S in the case of headlamps referred to in item 1.2,
 - H in the case of headlamps referred to in items 1.3. and 1.4.,
 - HS in the case of headlamps referred to in item 1.5,
 - D in the case of headlamps referred to in item 1.7.;
- 5.2.3.7. on headlamps incorporating a lens of plastic material, the letters PL shall be affixed near the symbols prescribed in items 5.2.3.3. to 5.2.3.5. above;

- 5.2.3.8. on headlamps referred to in items 1.3., 1.4., 1.5. and 1.7. meeting the requirements of this Directive in respect of the driving beam, an indication of the maximum luminous intensity expressed by a reference mark, placed near the rectangle surrounding the letter "e"; in the case of reciprocally incorporated headlamps, indication of the maximum luminous intensity of the driving beams as a whole shall be expressed as above.

The reference mark mentioned above is defined in

- paragraph 6.3.2.1.2. of the documents referred to in item 2.1., of Annexes IV and V,
- paragraph 8.3.2.1.2. of the documents referred to in item 2.1 of Annex VI,
- paragraph 6.3.2.2. of the documents referred to in item 2.1. of Annex VIII,

as applicable.

- 5.2.3.9. In every case the relevant operating mode used during the test procedure according to paragraph 1.1.1.1. of Annex "X" and the permitted voltage(s) according to paragraph 1.1.1.2. of Annex "X" shall be stipulated on the type-approval certificate (Appendix 3).

In the corresponding cases the device shall be marked as follows:

On headlamps meeting the requirements of this Directive which are so designed that the filament of the passing beam shall not be lit simultaneously with that of any other lighting function with which it may be reciprocally incorporated: an oblique stroke (/) shall be placed behind the passing lamp symbol in the approval mark.

On headlamps referred to in items 1.1., 1.3. and 1.4. meeting the requirements of Annex "X" to this Directive only when supplied with a voltage of 6 V or 12 V, a symbol consisting of the number 24 crossed out by an oblique cross (X) shall be placed near the filament lamp holder.

Annex "X" means:

- Annex 4 of the documents referred to in point 2.1. of Annexes II and VIII to this Directive,
- Annex 5 of the documents referred to in point 2.1. of Annexes III, IV and V to this Directive,
- Annex 6 of the documents referred to in point 2.1 of Annex VI to this Directive,

as applicable.

- 5.3. The EC component type-approval mark shall be affixed to the lamp in such a way as to be indelible and clearly legible even when the lamp is fitted to the vehicle.

- 5.4. Arrangement of the approval mark.

- 5.4.1. Independent lamps:

Examples of the EC component type-approval mark are given in figure 1 of Appendix 5.

- 5.4.2. Grouped, combined or reciprocally incorporated lamps.

- 5.4.2.1. Where a single EC component type-approval number is issued, as per item 4.4. above, for a type of lighting and light-signalling device comprising a headlamp and other lamps, a single EC component type-approval mark may be affixed, consisting of:

-
- 5.4.2.1.1. a rectangle surrounding the letter “e” followed by the distinguishing number or letters of the Member State which has granted type approval (see point 5.2.1.);
- 5.4.2.1.2. the base approval number (see point 5.2.2., first half-sentence).
- 5.4.2.2. This mark may be located anywhere on the lamps which are grouped, combined or reciprocally incorporated, provided that:
- 5.4.2.2.1. it is visible after the installation of the lamps;
- 5.4.2.2.2. no light-transmitting components of the grouped, combined or reciprocally incorporated lamps can be removed without simultaneously removing the approval mark.
- 5.4.2.3. The identification symbol for each lamp corresponding to each Directive pursuant to which EC component type approval was granted, together with the sequence number (see point 5.2.2.) and, where necessary, the required arrow shall be marked:
- 5.4.2.3.1. either on the appropriate light-emitting surface;
- 5.4.2.3.2. or in a group, in such a way that each of the grouped, combined or reciprocally incorporated lamps may be clearly identified.
- 5.4.2.4. The dimensions of the components of this mark must not be less than the minimum dimensions specified for individual marks by the various Directives pursuant to which EC component type approval was granted.
- 5.4.2.5. Examples of an EC component type-approval mark for a lamp that is grouped, combined or reciprocally incorporated with other lamps are given in figure 2 of Appendix 5.
- 5.4.3. Lamps, the lens of which is used for different types of headlamps and which may be reciprocally incorporated or grouped with other lamps:
- 5.4.3.1. the provisions laid down in point 5.4.2. above shall apply;
- 5.4.3.2. in addition, where the same lens is used, the latter may bear the different approval marks relating to different types of headlamps or units of lamps, provided that the main body of the headlamp, even if it cannot be separated from the lens, also comprises the space described in item 3.1.1.2. above and bears the approval marks of the actual functions;
- 5.4.3.3. if different types of headlamps comprise the same main body, the latter may bear the different approval marks.
- 5.4.3.4. Examples of an EC component type-approval mark for lamps reciprocally incorporated with a headlamp are given in figure 3 of Appendix 5.
6. EC COMPONENT TYPE-APPROVAL MARK FOR LIGHT SOURCES
- 6.1. In addition to the markings referred to in point 3.1.2. or 3.1.3., every light source conforming to the type approved pursuant to this Directive shall bear an EC component type-approval mark.

- 6.2. This mark shall consist of:
- 6.2.1. a rectangle surrounding the letter "e" followed by the distinguishing number or letters of the Member State which has granted type-approval:
- | | | | |
|----|------------------------|-----|----------------|
| 1 | for Germany | 12 | for Austria |
| 2 | for France | 13 | for Luxembourg |
| 3 | for Italy | 17 | for Finland |
| 4 | for the Netherlands | 18 | for Denmark |
| 5 | for Sweden | 21 | for Portugal |
| 6 | for Belgium | 23 | for Greece |
| 9 | for Spain | IRL | for Ireland; |
| 11 | for the United Kingdom | | |
- 6.2.2. the approval code mentioned in item 4.5. in the vicinity of the rectangle.
- 6.3. The inscriptions and marks specified in points 3.1.2., 3.1.3. and 6.1. shall be clearly legible and indelible.
- 6.4. An example of an EC component type-approval mark for light source is given in figure 4 of Appendix 5.

7. MODIFICATIONS OF THE TYPE AND AMENDMENTS TO APPROVALS

- 7.1. In the case of modifications of the type approved pursuant to this Directive, the provisions of Article 5 of Directive 70/156/EEC shall apply.

8. CONFORMITY OF PRODUCTION

- 8.1. As a general rule, measures to ensure the conformity of production shall be taken in accordance with the provisions laid down in Article 10 of Directive 70/156/EEC.
- 8.2. In particular, the tests to be carried out pursuant to point 2.3.5. of Annex X to Directive 70/156/EEC are those prescribed in
- Annex 3 and Annex 7 paragraph 3 of the documents referred to in point 2.1 of Annex II,
 - Annex 3 and Annex 6 paragraph 3 of the documents referred to in point 2.1. of Annex III,
 - Annex 2 and Annex 6 paragraph 3 of the documents referred to in point 2.1. of Annex IV,
 - Annex 5 and Annex 6 paragraph 3 of the documents referred to in point 2.1. of Annex V,
 - Annex 5 and Annex 7 paragraph 3 of the documents referred to in point 2.1. of Annex VI,
 - Annexes 6 and 7 of the documents referred to in point 2.1. of Annex VII,
 - Annex 8 of the documents referred to in point 2.1. of Annex VIII, or
 - Annexes 6 and 7 of the documents referred to in point 2.1. of Annex IX, as applicable,

and the criteria to be used in selecting samples for the tests mentioned in points 2.4.2. and 2.4.3. of Annex X to Directive 70/156/EEC are those set out in

- Annex 8 of the documents referred to in point 2.1. of Annex II,
- Annex 7 of the documents referred to in point 2.1. of Annex III,
- Annex 7 of the documents referred to in point 2.1. of Annex IV,
- Annex 7 of the documents referred to in point 2.1. of Annex V,
- Annex 8 of the documents referred to in point 2.1. of Annex VI,
- Annexes 8 and 9 of the documents referred to in point 2.1. of Annex VII,
- Annex 9 of the documents referred to in point 2.1. of Annex VIII, or
- Annex 8 of the documents referred to in point 2.1. of Annex IX, as applicable.

8.3. The normal frequency of inspections authorised by the approval authority shall be one every two years.

Appendix 1

Information document No ...

relating to the EC component type-approval of headlamps which function as rain-beam and/or dipped-beam headlamps

(Directive 76/761/EEC, as last amended by Directive .../.../EC)

The following information, if applicable, must be supplied in triplicate and include a list of contents. Any drawings must be supplied in appropriate scale and in sufficient detail on size A4 or on a folder of A4 format. Photographs, if any, must show sufficient detail.

If the systems, components or separate technical units have electronic controls, information concerning their performance must be supplied.

0. GENERAL

0.1. Make (trade name of manufacturer):

0.2. Type:

0.5. Name and address of manufacturer:

0.7. In the case of components and separate technical units, location and method of affixing of the EC approval mark:

0.8. Address(es) of assembly plant(s):

1. DESCRIPTION OF THE DEVICE

1.1. Type of device:

1.1.1. Device function(s):

1.1.2. Category or class of device:

1.1.3. Colour of the light emitted or reflected:

1.2. Drawing(s) in sufficient detail to permit identification of the type of the device and showing:

1.2.1. in what geometrical position the device is to be mounted on the vehicle (not applicable to rear registration plate lamps):

1.2.2. the axis of observation to be taken as the axis of reference in the tests (horizontal angle $H = 0^\circ$, vertical angle $V = 0^\circ$) and the point to be taken as the centre of reference in the said tests (not applicable to retro-reflecting devices and rear registration plate lamps):

1.2.3. the position intended for the EC component type-approval mark:

1.2.4. for rear registration plate lamps, the geometrical position in which the device is to be fitted in relation to the space to be occupied by the registration plate, and the outline of the area adequately illuminated:

1.2.5. for headlamps and front fog lamps, a frontal view of the lamps with details of lens ribbing, if any, and the cross section:

1.3. A brief technical description stating, in particular, with the exception of lamps with non-replaceable light sources, the category or categories of light sources prescribed which shall be one or more of those contained in Directive 76/761/EEC (not applicable to retro-reflecting devices):

- 1.4. Specific information
- 1.4.1. For rear registration plate lamps, a statement whether the device is intended to illuminate a wide/tall/both wide and tall plate:.....
- 1.4.2. For headlamps,
- 1.4.2.1. information whether the headlamp is intended to provide both a dipped beam and main beam or only one of those beams:.....
- 1.4.2.2. information in case the headlamp is intended to provide a dipped beam, if it is designed for both left-hand and right-hand traffic or for either left-hand or right-hand traffic only:.....
- 1.4.2.3. if the headlamp is equipped with an adjustable reflector, an indication of the mounting position(s) of the headlamp in relation to the ground and the longitudinal median plane of the vehicle, if the headlamp is for use in that (those) position(s) only:.....
- 1.4.3. For position lamps, stop lamps and direction indicators.....
- 1.4.3.1. if the device may also be used in an assembly of two lamps of the same category:.....
- 1.4.3.2. in the case of devices with two levels of intensity (stop lamps and category 2b direction indicators), arrangement diagram and specification of the characteristics of the system ensuring the two levels of intensity:.....
- 1.4.4. For retro-reflecting devices, a brief description giving the technical specifications of the materials of the retro-reflecting optical unit:
- 1.4.5. For reversing lamps, a statement whether the device is intended to be installed on a vehicle exclusively in a pair of devices:
-

Appendix 2

Information document No ...

relating to the EC component type-approval of light sources for use in approved lamp units

(Directive 76/761/EEC, as last amended by Directive .../EC)

The following information, if applicable, must be supplied in triplicate and include a list of contents. Any drawings must be supplied in appropriate scale and in sufficient detail on size A4 or on a folder of A4 format. Photographs, if any, must show sufficient detail.

If the systems, components or separate technical units have electronic controls, information concerning their performance must be supplied.

0. GENERAL

- 0.1. Make (trade name of manufacturer):.....
- 0.2. Type:.....
- 0.5. Name and address of manufacturer:
- 0.7. In the case of components and separate technical units, location and method of affixing of the EC approval mark:
- 0.8. Address(es) of assembly plant(s):.....

1. DESCRIPTION OF THE DEVICE

- 1.1. Category of device:.....
- 1.2. Colour of the light emitted:
- 1.3. Rated voltage:
- 1.4. Rated wattage:.....
- 1.5. A brief technical description:
- 1.6. Drawing(s), sufficiently detailed to permit identification of the type:.....
- 1.7. In the case of gas-discharge light sources, ballast identification:

Date, file

Appendix 3

MODEL

(maximum format: A4 (210 x 297 mm))

EC TYPE-APPROVAL CERTIFICATE

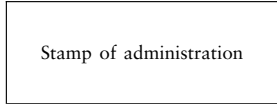

Communication concerning the

- type-approval(1)
- extension of type-approval(1)
- refusal of type-approval(1)
- withdrawal of type-approval(1)

of a type of a vehicle/component/separate technical unit(1) with regard to Directive .../EEC, as last amended by Directive .../EC

Type-approval number:

Reason for extension:

SECTION I

- 0.1. Make (trade name of manufacturer):
0.2. Type:
0.3. Means of identification of type if marked on the vehicle/component/separate technical unit(1)(2):
0.3.1. Location of that marking:
0.4. Category of vehicle(1)(3):
0.5. Name and address of manufacturer:
0.7. In the case of components and separate technical units, location and method of affixing of the EC approval mark:
0.8. Address(es) of assembly plant(s):

SECTION II

- 1. Additional information (where applicable): See Addendum
2. Technical service responsible for carrying out the tests:
3. Date of test report:
4. Number of test report:
5. Remarks (if any): See Addendum
6. Place:

7. Date:
8. Signature:
9. The index to the information package lodged with the approval authority, which may be obtained on request, is attached.

⁽¹⁾ Delete where not applicable.

⁽²⁾ If the means of identification of type contains characters not relevant to describe the vehicle, component or separate technical unit types covered by this type-approval certificate such characters shall be represented in the documentation by the symbol: “?” (e. g. ABC??123??).

⁽³⁾ As defined in Annex II A to Directive 70/156/EEC.

—————

Addendum to EC type-approval certificate No ...

concerning the component type-approval of a lighting and/or light-signalling device with regard to Directive(s) 76/757/EEC; 76/758/EEC; 76/759/EEC; 76/760/EEC; 76/761/EEC; 76/762/EEC; 77/538/EEC; 77/539/EEC and 77/540/EEC⁽¹⁾ as last amended by Directive(s) ...

1. Additional information

1.1. Where applicable, indicate for each lamp

1.1.1. The category(ies) of the device(s):.....

1.1.2. The number and category of light sources (not applicable to retro reflector⁽²⁾):.....

1.1.3. The colour of the light emitted or reflected:.....

1.1.4. Approval granted solely for use as a replacement part on vehicles already in service: Yes/No⁽¹⁾

1.2. Specific information for certain types of lighting or light-signalling devices

1.2.1. For retro-reflecting devices: In isolation/part of an assembly of devices⁽¹⁾

1.2.2. For rear registration plate lamps: Device for illuminating a tall plate/a wide plate⁽¹⁾

1.2.3. For headlamps: If equipped with an adjustable reflector, the mounting position(s) of the headlamp in relation to the ground and the longitudinal median plane of the vehicle, if the headlamp is for use in that (those) position(s) only:

1.2.4. For reversing lamps: This device shall be installed on a vehicle only as part of a pair of devices: Yes/No⁽¹⁾

5. Remarks

5.1. Drawings

5.1.1. For rear registration plate lamps: the attached drawing No ... shows the geometric position in which the device is to be fitted in relation to the space to be occupied by the registration plate, and the outline of the area adequately illuminated;

5.1.2. for retro-reflecting devices: the attached drawing No ... shows the geometric position in which the device is to be fitted to the vehicle;

5.1.3. For all other lighting and light-signalling devices: the attached drawing No ... shows the geometric position in which the device is to be fitted to the vehicle, and the axis of reference and centre of reference of the device.

5.2. For headlamps: Operating mode used during the test (item 5.2.3.9 of Annex I to Directive 76/761/EEC):

⁽¹⁾ Delete where not applicable.

⁽²⁾ For lamps with non-replaceable light sources, indicate the number and the total wattage of the light sources.

Appendix 4

MODEL

(maximum format: A4 (210 x 297 mm))

EC TYPE-APPROVAL CERTIFICATE

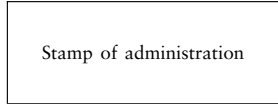

Communication concerning the

- type-approval(1)
- extension of type-approval(1)
- refusal of type-approval(1)
- withdrawal of type-approval(1)

of a type of a vehicle/component/separate technical unit(1) with regard to Directive .../EEC, as last amended by Directive .../EC

Type-approval number:

Reason for extension:

SECTION I

- 0.1. Make (trade name of manufacturer):
0.2. Type:
0.3. Means of identification of type if marked on the vehicle/component/separate technical unit(1)(2):
0.3.1. Location of that marking:
0.4. Category of vehicle(1)(3):
0.5. Name and address of manufacturer:
0.7. In the case of components and separate technical units, location and method of affixing of the EC approval mark:
0.8. Address(es) of assembly plant(s):

SECTION II

- 1. Additional information (where applicable): See Addendum
2. Technical service responsible for carrying out the tests:
3. Date of test report:
4. Number of test report:
5. Remarks (if any): See Addendum
6. Place:

- 7. Date:
- 8. Signature:
- 9. The index to the information package lodged with the approval authority, which may be obtained on request, is attached.

(¹) Delete where not applicable.
 (²) If the means of identification of type contains characters not relevant to describe the vehicle, component or separate technical unit types covered by this type-approval certificate such characters shall be represented in the documentation by the symbol: “?” (e. g. ABC??123??).
 (³) As defined in Annex II A to Directive 70/156/EEC.



Addendum to EC type-approval certificate No ...

concerning the component type-approval of a light source for use in approved lamp units with regard to Directive 76/761/EEC, as last amended by Directive .../.../EC

1. Additional information

- 1.1. Category of device:.....
- 1.2. Colour of the light emitted:
- 1.3. Rated voltage:
- 1.4. Rated wattage:.....
- 1.5. Trade name and type number of ballast, where applicable:

5. Remarks

- 5.1. The attached drawing No. ... shows the entire light source.



Appendix 5

EXAMPLES OF THE EC COMPONENT TYPE-APPROVAL MARK

Figure 1

Independent lamps

Example 1

a ≥ 12 mm

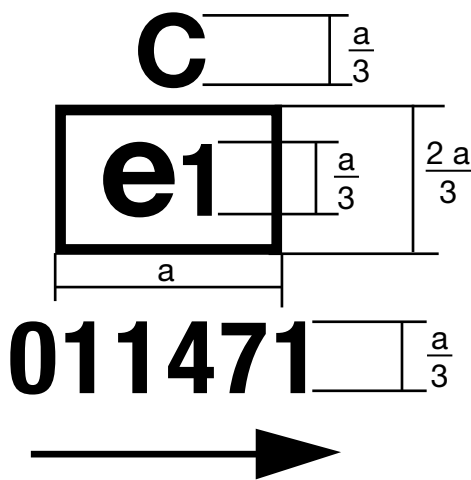

The device bearing the EC component type-approval mark shown above is a headlamp meeting the requirements of Annex II (sequence No 01) with respect to the passing beam and designed for left-hand traffic only, type approved in Germany (e1) under the base approval number 1471.

Example 2

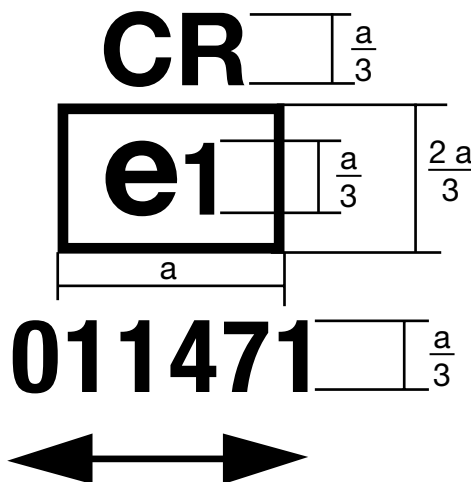

The device bearing the EC component type-approval mark shown above is a headlamp meeting the requirements of Annex II (sequence No 01) with respect to both the passing beam and the driving beam and designed for both traffic systems by means of adjustment of the optical unit or of the lamp, type approved in Germany (e1) under the base approval number 1471.

Example 3

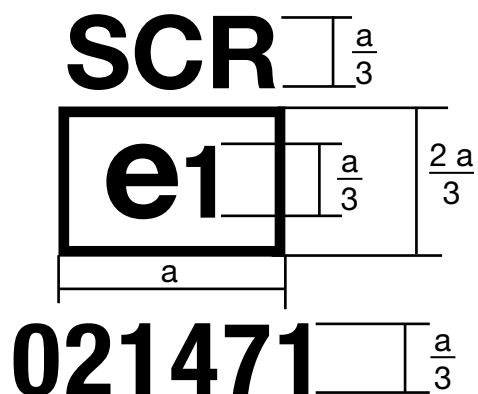

The device bearing the EC component type-approval mark shown above is a sealed-beam headlamp meeting the requirements of Annex III (sequence No 02) with respect to both the passing beam and the driving beam and designed for right-hand traffic only, type approved in Germany (e1) under the base approval number 1471.

Example 4

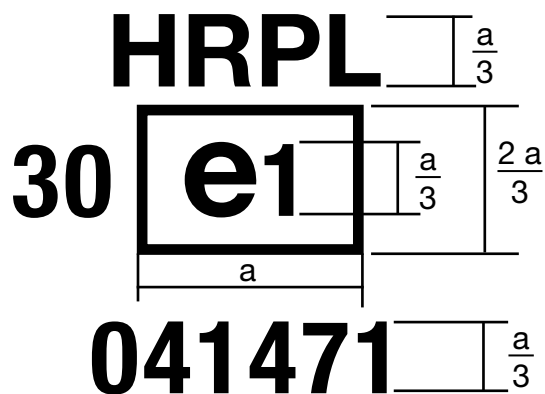

The device bearing the EC component type-approval mark shown above is a headlamp incorporating a lens of plastic material, meeting the requirements of Annex IV (sequence No 04) with respect to the driving beam and designed for right-hand traffic only, type approved in Germany (e1) under the base approval number 1471. The number 30 indicates that the maximum luminous intensity of the driving beam is between 86 250 and 101 250 candelas.

Example 5

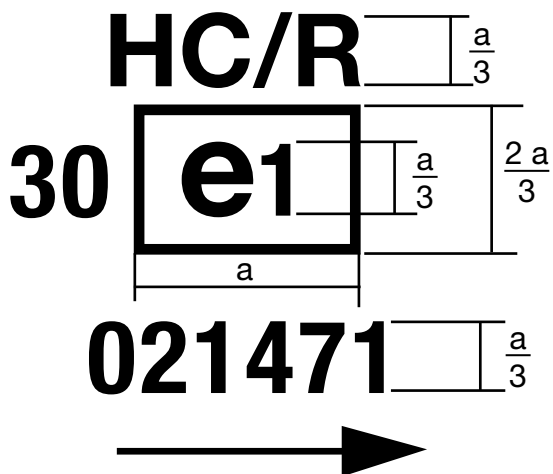

The device bearing the EC component type-approval mark shown above is a headlamp meeting the requirements of Annex V (sequence No 02) with respect to both the passing beam and the driving beam and designed for left-hand traffic only, type approved in Germany (e1) under the base approval number 1471. The passing lamp filament shall not be lit simultaneously with the driving lamp filament or any other headlamp with which it is reciprocally incorporated. For the meaning of the number 30, see example 4.

Example 6

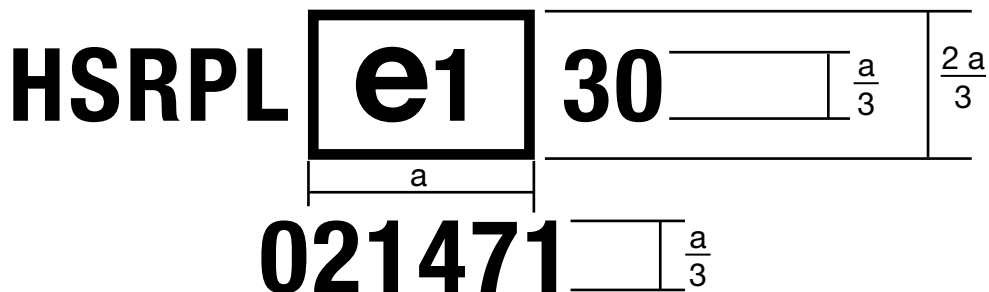

The device bearing the EC component type-approval mark shown above is a halogen sealed-beam headlamp incorporating a lens of plastic material, meeting the requirements of Annex VI (sequence No 02) with respect to the driving beam and designed for right-hand traffic only, type approved in Germany (e1) under the base approval number 1471. For the meaning of the number 30, see example 4.

Example 7

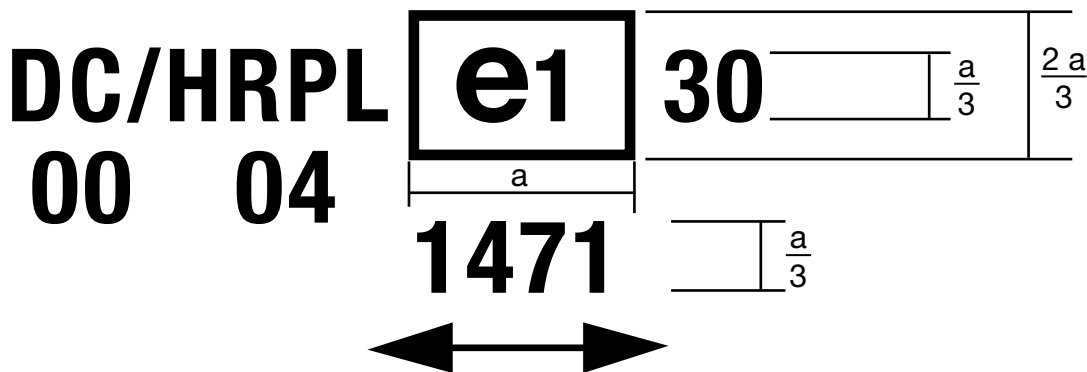

The device bearing the EC component type-approval mark shown above is headlamp incorporating a lens of plastic material, meeting the requirements of Annex VIII (sequence No 00) with respect to the passing beam and designed for both traffic systems, type approved in Germany (e1) under the base approval number 1471, which is combined or grouped or reciprocally incorporated with a driving beam meeting the requirements of Annex IV (sequence No 04). The passing beam shall not be lit simultaneously with the driving beam. For the meaning of the number 30, see example 4.

Figure 2

Simplified marking of grouped, combined or reciprocally incorporated lamps when two or more lamps are part of the same assembly

(The vertical and horizontal lines schematise the shape of the light-signalling device. These are not part of the approval mark)

MODEL A

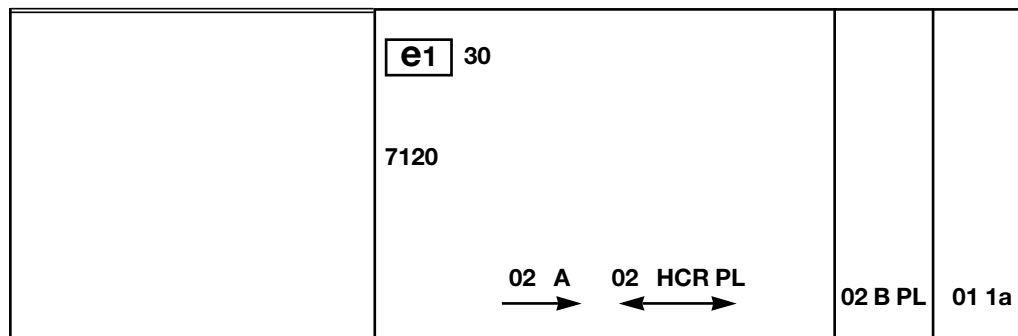

MODEL B

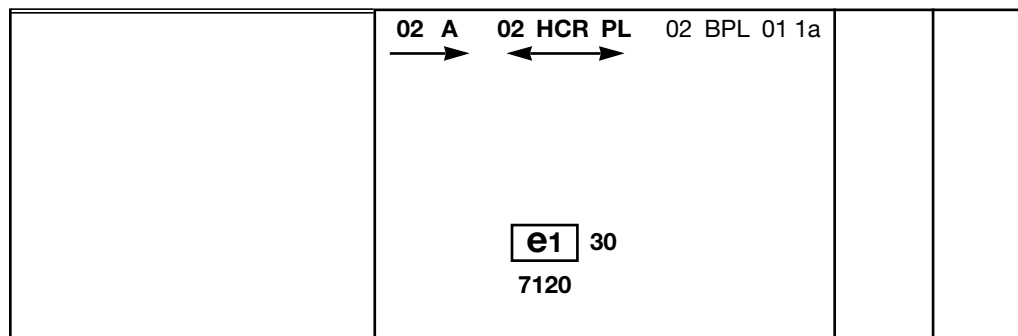

MODEL C

A 02 →	HCR PL 02 ↔	B PL 02	1a 01		
<div style="border: 1px solid black; display: inline-block; padding: 2px;">e1</div> 30 7120					

MODEL D

	02 A <div style="border: 1px solid black; display: inline-block; padding: 2px;">e1</div> 30 7120 02 HCR PL → ↔	02 BPL 01 1a		
--	---	--------------	--	--

Note: The four examples of approval marks, models A, B, C and D represent four possible variants of the marking of a lighting and light-signalling device when two or more lamps are part of the same unit of grouped, combined or reciprocally incorporated lamps. These approval marks show that the device was approved in Germany (e1) under the base approval number 7120 and comprises:

a front position lamp (A) approved in accordance with Annex II to Directive 76/758/EEC, sequence No 02, for left-hand installation;

a headlamp (HCR) with a passing beam designed for right-hand and left-hand traffic and driving beam with a maximum intensity comprised between 86 250 and 101 250 candelas (as indicated by the number 30) approved in accordance with Annex V to Directive 76/761/EEC, sequence No 02, and incorporating a lens of plastic material (PL);

a front fog lamp (B) approved in accordance with Directive 76/762/EEC, sequence No 02, and incorporating a lens of plastic material (PL);

a front direction indicator lamp of category 1a approved in accordance with Directive 76/759/EEC, sequence No 01.

Figure 3

Lamp reciprocally incorporated or grouped with a headlamp

Example 1

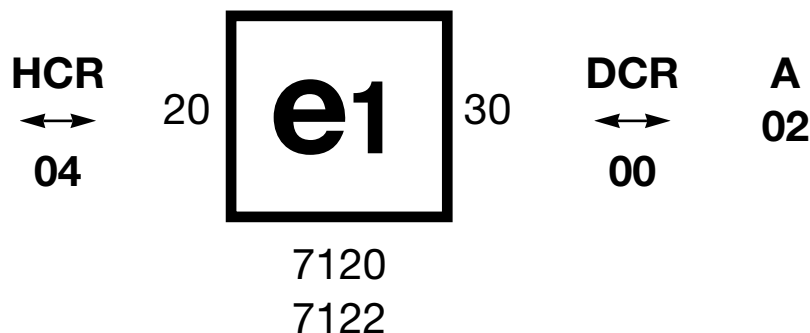

The above example corresponds to the marking of a lens intended to be used in different types of headlamps, namely:

either:

a headlamp with a passing beam designed for both traffic systems and a driving beam with a maximum luminous intensity comprised between 52 500 and 67 500 candelas (as indicated by the number 20) approved in Germany (e1) under the base approval number 7120 in accordance with the requirements of Annex IV to Directive 76/761/EEC, sequence No 04, which is reciprocally incorporated with a front position lamp approved in accordance with Annex II to Directive 76/758/EEC, sequence No 02,

or:

a headlamp with a gas discharge passing beam and a driving beam with a maximum luminous intensity comprised between 86 250 and 101 250 candelas (as indicated by the number 30), designed for both traffic systems and approved in Germany (e1) under the base approval number 7122 in accordance with the requirements of Annex VIII to Directive 76/761/EEC, sequence No 00, which is reciprocally incorporated with the same front position lamp as above,

or:

even either of the abovementioned headlamps approved as a single lamp.

The main body of the headlamp shall bear the only valid approval number, for instance:

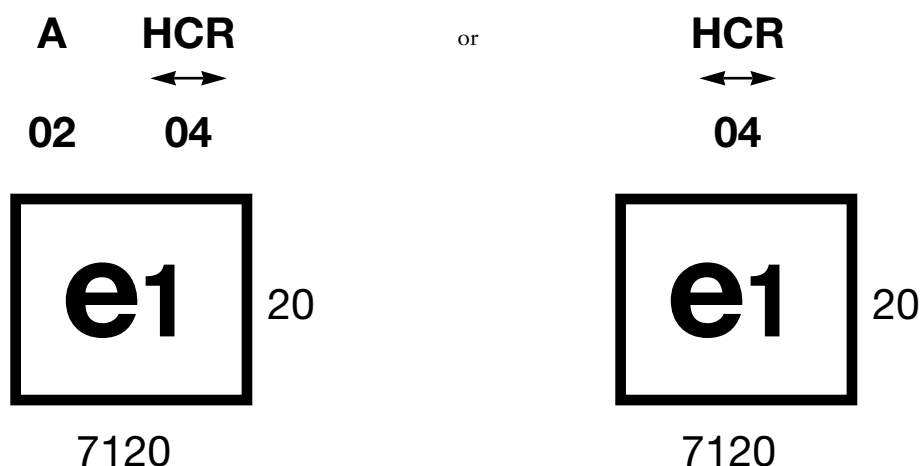

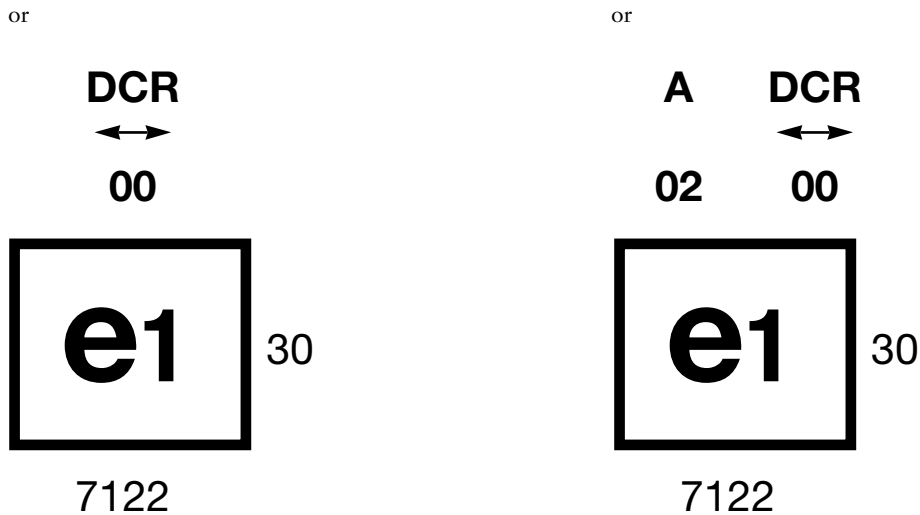

Example 2

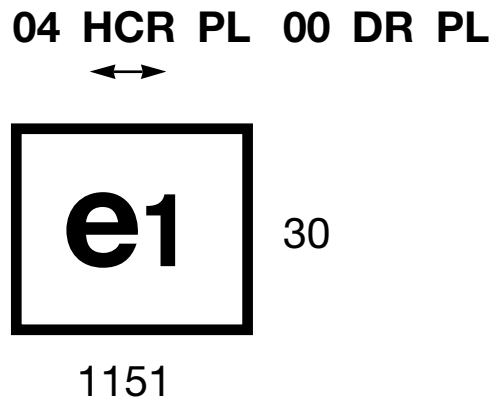

The above example corresponds to the marking of a lens of plastic material and used in an assembly of two headlamps approved in Germany (e1) under the base approval number 1151, consisting of:

- a headlamp emitting a halogen passing beam designed for both traffic systems and a halogen driving beam with a maximum luminous intensity between x and y candelas, meeting the requirements of Annex IV to Directive 76/761/EEC, sequence No 04, and
- a headlamp emitting a gas discharge driving beam with a maximum luminous intensity comprised between w and z candelas, meeting the requirements of Annex VIII to Directive 76/761/EEC, sequence No 00, the maximum luminous intensities of the driving beam contributors as a whole being comprised between 86 250 and 101 250 candelas as shown by the number 30.

Figure 4

Light sources

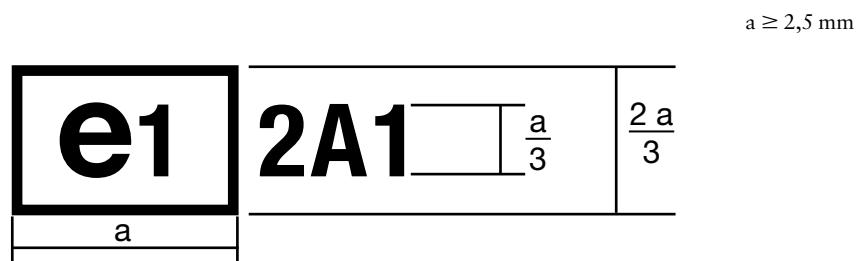

The above approval mark affixed to a light source indicates that this light source has been approved in Germany (e1) under the approval code 2A1. Its first character indicates that the light source meets the requirements of Annex VII with respect to filament lamps.

ANNEX II

SCOPE AND TECHNICAL REQUIREMENTS

1. SCOPE

This Annex applies to motor vehicle headlamps emitting an asymmetrical passing beam or a driving beam or both and equipped with filament lamps of categories R2 and/or HS1.

2. TECHNICAL REQUIREMENTS

2.1. The technical requirements are those set out in paragraphs 1 and 5 to 8 and Annexes 3, 4 and 6 to 8 of UN-ECE Regulation No 1 which consists of a consolidation of the following documents:

- the 01 series of amendments including Supplements 1 to 3 to the 01 series of amendments⁽¹⁾,
- Supplement 4 to the 01 series of amendments⁽²⁾,
- Supplement 5 to the 01 series of amendments including Corrections to Supplement 3 to the 01 series of amendments and Corrections to Revision 4 of Regulation No 1⁽³⁾,
- Supplement 6 to the 01 series of amendments⁽⁴⁾,
- Supplement 7 to the 01 series of amendments⁽⁵⁾,

except that:

- 2.1.1. Where reference is made to "Regulation No 37", this shall be understood as "Annex VII to this Directive".
- 2.1.2. In paragraph 6.5., "paragraph 2.1." means "point 1.4.2.3. in Appendix 1 of Annex I to this Directive".
- 2.1.3. In Annex 3, paragraph 2.5., "paragraph 9.1. of this Regulation" means "point 2.1. of Annex X to Directive 70/156/EEC".
- 2.1.4. In Annex 7, paragraph 1.1. and Appendix 1, the title of Table A, "paragraph 2.2.4. of this Regulation" means "point 2.1.2.2. of Annex I to this Directive".
- 2.1.5. In Annex 7, paragraph 1.2. and Appendix 1, the title of Table B, "paragraph 2.2.3. of this Regulation" means "point 2.1.2.1. of Annex I to this Directive".
- 2.1.6. In Annex 7, paragraph 2.4.2., "paragraph 2.2.4. above" means "point 2.1.2.2.2. of Annex I to this Directive".
- 2.1.7. In Annex 8, paragraphs 2.3. and 3.3., "paragraph 10" means "Article 11 of Directive 70/156/EEC".
- 2.1.8. Only headlamps emitting a light of white colour shall be approved pursuant to this Directive.

⁽¹⁾ E/ECE/324
E/ECE/TRANS/505 } Add. 1/Rev. 4.

⁽²⁾ E/ECE/324
E/ECE/TRANS/505 } Add. 1/Rev. 4/Amend. 1.

⁽³⁾ E/ECE/324
E/ECE/TRANS/505 } Add. 1/Rev. 4/Amend. 2.

⁽⁴⁾ TRANS/WP.29/489.

⁽⁵⁾ TRANS/WP.29/535.

ANNEX III

SCOPE AND TECHNICAL REQUIREMENTS

1. SCOPE

This Annex applies to motor vehicle "sealed-beam" headlamps emitting an asymmetrical passing beam or a driving beam or both.

2. TECHNICAL REQUIREMENTS

2.1. The technical requirements are those set out in paragraphs 2, 6 to 8 and 11 and Annexes 3, 4 (pages 32 to 39 of reference document⁽¹⁾) and 5 to 7 of UN-ECE Regulation No 5 which consists of a consolidation of the following documents:

- the 01 and 02 series of amendments including Supplements 1 and 2 to the 02 series of amendments⁽¹⁾,
- Corrigendum 1 to Revision 3 of Regulation No 5⁽²⁾,
- Supplement 3 to the 02 series of amendments⁽³⁾,
- Supplement 4 to the 02 series of amendments⁽⁴⁾,

except that:

2.1.1. In Annex 3, paragraph 2.5., "paragraph 12.1 of this Regulation" means "point 2.1. of Annex X to Directive 70/156/EEC".

2.1.2. In Annex 6, paragraph 1.1. and Appendix 1, the title of Table A, "paragraph 3.2.4. of this Regulation" means "point 2.1.2.2. of Annex I to this Directive".

2.1.3. In Annex 6, paragraph 1.2. and Appendix 1, the title of Table B, "paragraph 3.2.3. of this Regulation" means "point 2.1.2.1. of Annex I to this Directive".

2.1.4. In Annex 6, paragraph 2.4.2., "paragraph 2.2.4. above" means "point 2.1.2.2.2. of Annex I to this Directive".

2.1.5. In Annex 7, paragraphs 2.3 and 3.3., "paragraph 13" means "Article 11 of Directive 70/156/EEC".

2.1.6. Only headlamps emitting a light of white colour shall be approved pursuant to this Directive.

⁽¹⁾ E/ECE/324
E/ECE/TRANS/505 } Add. 4/Rev. 3.

⁽²⁾ E/ECE/324
E/ECE/TRANS/505 } Add. 4/Rev. 3/Corr. 1.

⁽³⁾ TRANS/WP. 29/491.

⁽⁴⁾ TRANS/WP. 29/567.

ANNEX IV

SCOPE AND TECHNICAL REQUIREMENTS

1. SCOPE

This Annex applies to motor vehicle headlamps emitting an asymmetrical passing beam or a driving beam or both and equipped with halogen filament lamps of categories H₁, H₂, H₃, HB₃, HB₄, H₇ and/or H₈.

2. TECHNICAL REQUIREMENTS

2.1. The technical requirements are those set out in paragraphs 1, 5, 6, 8 and 9 and Annexes 2, and 4 to 7 of UN-ECE Regulation No 8 which consist of a consolidation of the following documents:

- the 01 to 04 series of amendments including Supplements 1 to 4 to the 04 series of amendments⁽¹⁾,
- Supplement 5 to the 04 series of amendments⁽²⁾,
- Corrigendum 1 to Supplement 4 to the 04 series of amendments⁽³⁾,
- Corrigendum 2 to Revision 3 of Regulation No 8⁽⁴⁾,
- Supplement 6 to the 04 series of amendments⁽⁵⁾,
- Supplement 7 to the 04 series of amendments⁽⁶⁾,
- Supplement 8 to the 04 series of amendments⁽⁷⁾,
- Supplement 9 to the 04 series of amendments⁽⁸⁾,
- Supplement 10 to the 04 series of amendments⁽⁹⁾,

except that:

- 2.1.1. Where reference is made to "Regulation No 37", this shall be understood as "Annex VII to this Directive".
- 2.1.2. In paragraph 6.3.2.1.2., "paragraph 4.2.2.7." means "item 5.2.3.8 of Annex I to this Directive".
- 2.1.3. In paragraph 6.4., "paragraph 2.1.3." means "item 1.4.2.3. in Appendix 1 of Annex I to this Directive".
- 2.1.4. In Annex 2, paragraph 2.5., "paragraph 12.1. of this Regulation" means "item 2.1. of Annex X to Directive 70/156/EEC".

(¹) E/ECE/324 E/ECE/TRANS/505	}	Add. 7/Rev. 3.
(²) E/ECE/324 E/ECE/TRANS/505	}	Add. 7/Rev. 3/Amend. 1.
(³) E/ECE/324 E/ECE/TRANS/505	}	Add. 7/Rev. 3/Corr. 1.
(⁴) E/ECE/324 E/ECE/TRANS/505	}	Add. 7/Rev. 3/Corr. 2.
(⁵) TRANS/WP. 29/492.		
(⁶) TRANS/WP. 29/520.		
(⁷) TRANS/WP.29/538.		
(⁸) TRANS/WP.29/585.		
(⁹) TRANS/WP.29/623.		

- 2.1.5. In Annex 6, paragraph 1.1. and Appendix 1, the title of Table A, “paragraph 2.2.4. of this Regulation” means “point 2.1.2.2. of Annex I to this Directive”.
- 2.1.6. In Annex 6, paragraph 1.2. and Appendix 1, the title of Table B, “paragraph 2.2.3. of this Regulation” means “point 2.1.2.1. of Annex I to this Directive”.
- 2.1.7. In Annex 6, paragraph 2.4.2., “paragraph 2.2.4. above” means “point 2.1.2.2.2. of Annex I to this Directive”.
- 2.1.8. In Annex 7, paragraphs 2.3 and 3.3, “paragraph 13” means “Article 11 of Directive 70/156/EEC”.
- 2.1.9. Only headlamps emitting a light of white colour shall be approved pursuant to this Directive.
-

ANNEX V

SCOPE AND TECHNICAL REQUIREMENTS

1. SCOPE

This Annex applies to motor vehicle headlamps emitting an asymmetrical passing beam or a driving beam or both and equipped with halogen filament lamps of category H₄.

2. TECHNICAL REQUIREMENTS

2.1. The technical requirements are those set out in paragraphs 1, 5, 6, 8 and 9 and Annexes 3 to 7 of UN-ECE Regulation No 20 which consists of a consolidation of the following documents:

- the 01 and 02 series of amendments including Supplements 1 to 3 to the 02 series of amendments⁽¹⁾,
- Supplement 4 to the 02 series of amendments⁽²⁾,
- Supplement 5 to the 02 series of amendments including Corrections to Supplement 3 to the 02 series of amendments and Corrections to Revision 2 of Regulation No 20⁽³⁾,
- Supplement 4 to the 02 series of amendments⁽⁴⁾,

except that:

- 2.1.1. Where reference is made to "Regulation No 37", this shall be understood as "Annex VII to this Directive".
- 2.1.2. In paragraph 6.3.2.1.2., "paragraph 4.2.2.7." means "point 5.2.3.8. of Annex I to this Directive".
- 2.1.3. In paragraph 6.4., "paragraph 2.1.3." means "point 1.4.2.3. in Appendix 1 of Annex I to this Directive".
- 2.1.4. In Annex 5, paragraph 2.5., "paragraph 12.1. of this Regulation" means "point 2.1. of Annex X to Directive 70/156/EEC".
- 2.1.5. In Annex 6, paragraph 1.1. and Appendix 1, the title of Table A, "paragraph 2.2.4. of this Regulation" means "point 2.1.2.2. of Annex I to this Directive".
- 2.1.6. In Annex 6, paragraph 1.2. and Appendix 1, the title of Table B, "paragraph 2.2.3. of this Regulation" means "point 2.1.2.1. of Annex I to this Directive".
- 2.1.7. In Annex 6, paragraph 2.4.2., "paragraph 2.2.4.1.1. of this Regulation" means "point 2.1.2.2.2. of Annex I to this Directive".
- 2.1.8. In Annex 7, paragraphs 2.3. and 3.3., "paragraph 13" means "Article 11 of Directive 70/156/EEC".
- 2.1.9. Only headlamps emitting a light of white colour shall be approved pursuant to this Directive.

⁽¹⁾ E/ECE/324
E/ECE/TRANS/505 } Rev. 1/Add. 19/Rev. 2.

⁽²⁾ E/ECE/324
E/ECE/TRANS/505 } Rev. 1/Add. 19/Rev. 2/Amend. 1.

⁽³⁾ E/ECE/324
E/ECE/TRANS/505 } Rev. 1/Add. 19/Rev. 2/Amend. 2.

⁽⁴⁾ TRANS/WP. 29/541.

ANNEX VI

SCOPE AND TECHNICAL REQUIREMENTS

1. SCOPE

This Annex applies to halogen "sealed-beam" motor vehicle headlamps emitting an asymmetrical passing beam or a driving beam or both.

2. TECHNICAL REQUIREMENTS

2.1. The technical requirements are those set out in paragraphs 2, 6 to 8 and 10 and Annexes 3 to 8 of UN-ECE Regulation No 31 which consists of a consolidation of the following documents:

- the 1 and 02 series of amendments including Supplements 1 and 2 to the 02 series of amendments⁽¹⁾,
- Corrigendum 1 to Revision 1 of Regulation No 31⁽²⁾,
- Supplement 3 to the 02 series of amendments⁽³⁾,
- Supplement 3 to the 02 series of amendments⁽⁴⁾,

except that:

- 2.1.1. In paragraph 8.3.2.1.2., "paragraph 5.2.2.5." means "point 5.2.3.8. of Annex I to this Directive".
- 2.1.2. In Annex 5, paragraph 2.5., "paragraph 11.1. of this Regulation" means "point 2.1. of Annex X to Directive 70/156/EEC".
- 2.1.3. In Annex 7, paragraph 1.1. and Appendix 1, the title of Table A, "paragraph 3.2.4. of this Regulation" means point 2.1.2.2. of Annex I to this Directive.
- 2.1.4. In Annex 7, paragraph 1.2 and Appendix 1, the title of Table B, "paragraph 3.2.3. of this Regulation" means "point 2.1.2.1. of Annex I to this Directive".
- 2.1.5. In Annex 7, paragraph 2.4.2, "paragraph 3.2.4.1.1. of this Regulation" means "point 2.1.2.2.2. of Annex I to this Directive".
- 2.1.6. In Annex 8, paragraphs 2.3. and 3.3., "paragraph 12" means "Article 11 of Directive 70/156/EEC".
- 2.1.7. Only headlamps emitting a light of white colour shall be approved pursuant to this Directive.

⁽¹⁾ E/ECE/324
E/ECE/TRANS/505 } Rev. 1/Add. 30/Rev. 1.

⁽²⁾ E/ECE/324
E/ECE/TRANS/505 } Rev. 1/Add. 30/Rev. 1/Corr. 1.

⁽³⁾ TRANS/WP.29/497.

⁽⁴⁾ TRANS/WP.29/569.

ANNEX VII

SCOPE AND TECHNICAL REQUIREMENTS

1. SCOPE

This Annex applies to filament lamps for use in approved lamp units of motor vehicles and of their trailers.

2. TECHNICAL REQUIREMENTS

2.1. The technical requirements are those set out in paragraphs 2.1. and 3. and Annexes 1 and 4 to 9 of UN-ECE Regulation No 37 which consists of a consolidation of the following documents:

- the 02 and 03 series of amendments including Corrigendum 2 and Supplements 1 to 9 to the 03 series of amendments⁽¹⁾,
- Corrigendum 1 to Revision 2⁽²⁾,
- Supplement 10 to 12 to the 03 series of amendments⁽³⁾,
- Supplement 13 to the 03 series of amendments⁽⁴⁾,
- Supplement 14 to the 03 series of amendments⁽⁵⁾,
- Supplement 15 to the 03 series of amendments⁽⁶⁾,

except that:

2.1.1. In Annex 6, paragraph 2.5., “paragraph 4.1. of this Regulation” means “item 2.1. of Annex X to Directive 70/156/EEC”.

⁽¹⁾ E/ECE/324
E/ECE/TRANS/505 } Rev. 1/Add. 36/Rev. 2.

⁽²⁾ E/ECE/324
E/ECE/TRANS/505 } Rev. 1/Add. 36/Rev. 2/Corr. 1.

⁽³⁾ E/ECE/324
E/ECE/TRANS/505 } Rev. 1/Add. 36/Rev. 2/Amend. 1.

⁽⁴⁾ TRANS/WP.29/498.

⁽⁵⁾ TRANS/WP.29/523.

⁽⁶⁾ TRANS/WP.29/586.

ANNEX VIII

SCOPE AND TECHNICAL REQUIREMENTS

1. SCOPE

This Annex applies to motor vehicle headlamps equipped with gas-discharge light sources.

2. TECHNICAL REQUIREMENTS

2.1. The technical requirements are those set out in paragraphs 1, 5, 6 and 7 and Annexes 3 to 9 of UN-ECE Regulation No 98, 38 which consists of a consolidation of the following documents:

- the Regulation in its original form (00)⁽¹⁾,
- Supplement 1 to Regulation No 98⁽²⁾,

except that:

- 2.1.1. Where reference is made to “Regulation No 99”, this shall be understood as “Annex IX to this Directive”.
- 2.1.2. In paragraph 1.5., “Regulation No 48” shall be understood as “Directive 76/756/EEC”.
- 2.1.3. In paragraph 6.3.2.2., “paragraph 4.2.2.7.” means “point 5.2.3.8 of Annex I to this Directive”.
- 2.1.4. In paragraph 6.5., “paragraph 2.1.4.” means “point 1.4.2.3. in Appendix 1 of Annex I to this Directive”.
- 2.1.5. In Annex 5, paragraph 1.1. and Appendix 1, the title of Table A, “paragraph 2.2.4. of this Regulation” means “point 2.1.2.2. of Annex I to this Directive”.
- 2.1.6. In Annex 5, paragraph 1.2. and Appendix 1, the title of Table B, “paragraph 2.2.3. of this Regulation” means “point 2.1.2.1. of Annex I to this Directive”.
- 2.1.7. In Annex 5, paragraph 2.4.2., “paragraph 2.2.4. above” means “point 2.1.2.2.2. of Annex I to this Directive”.
- 2.1.8. In Annex 8, paragraph 2.5., “paragraph 9.1. of this Regulation” means “point 2.1. of Annex X to Directive 70/156/EEC”.
- 2.1.9. In Annex 9, paragraphs 2.3. and 3.3., “paragraph 10”, means “Article 11 of Directive 70/156/EEC”.
- 2.1.10. Only headlamps emitting a light of white colour shall be approved pursuant to this Directive.

⁽¹⁾ E/ECE/324
E/ECE/TRANS/505 } Rev. 1/Add. 97.

⁽²⁾ TRANS/WP.29/553.

ANNEX IX

SCOPE AND TECHNICAL REQUIREMENTS

1. SCOPE

This Annex applies to gas-discharge light sources for use in approved gas-discharge lamp units of motor vehicles.

2. TECHNICAL REQUIREMENTS

2.1. The Technical requirements are those set out in paragraphs 2.1. and 3. and Annexes 1 and 4 to 8 of UN-ECE Regulation No 99 which consists of a consolidation of the following documents:

- the Regulation in its original form (00) ⁽¹⁾,
- Supplement 1 to Regulation No 99 ⁽²⁾,

except that:

2.1.1. In paragraphs 3.2.1. and 3.4.2. and in Annex 4, paragraph 2, “paragraph 2.2.2.4” means “point 2.2.2.2. of Annex I to this Directive”.

2.1.2. In Annex 6, paragraph 2.5., “paragraph 4.1. of this Regulation” means “point 2.1. of Annex X to Directive 70/156/EEC”.

⁽¹⁾ E/ECE/324
E/ECE/TRANS/505 } Rev. 1/Add. 98.

⁽²⁾ TRANS/WP.29/587.